

Make & Model	Year	Part No.	Description	Page No.
Audi				
80	8/78-3/87	EF1430	Radiator Fan Motor & Blade	445
80	8/84-8/86	EF1218	Radiator Fan Motor & Blade	445
80	86-95	EF1308	Radiator Fan Motor & Blade	445
80	86-95	EF1217	Radiator Fan Motor & Blade	445
90	87>	EF1308	Radiator Fan Motor & Blade	445
90	87>	EF1217	Radiator Fan Motor & Blade	445
100	82-90	EF1308	Radiator Fan Motor & Blade	445
100	71-76	EF1217	Radiator Fan Motor & Blade	445
A3	9/98>	EF1216	Radiator Fan Motor & Blade	445
A4	7/02-3/09	EF1312	Radiator Fan	445
A4	95-00	EF1310	Condenser Fan	445
A6, 3.0, 3.2Lt	09-11	EF1432	Dual Assembly	445
Q7	3/06-5/11	EF1219	Radiator Fan Motor & Blade	445
Q7	3/06>	EF1425	Radiator Fan Motor & Blade	446
Q7	3/06>	EF1426	Radiator Fan Motor & Blade	446
S4	04-09	EF1312	Radiator Fan	445
TT	9/98>	EF1216	Radiator Fan Motor & Blade	445
BMW				
3 Series, E30, 318i, 323i	82-87	EF6511	Condenser Fan	446
3 Series, E36, 4 cyl	95-02	EF6514	Condenser Fan	446
3 Series, E36	93-99	EF6501	Condenser Fan	446
3 Series, E36	93-95	EF6550	Radiator Fan	446
3 Series, E46	98-05	EF6550	Radiator Fan	446
3 Series, E46	98-5/05	EF6515	Condenser Fan	446
3 Series, E46, 318i	98-03	EF1155	Radiator Fan Motor & Blade	446
3 Series, E46, 318i	98-03	EF6555	Radiator Fan	446
5 Series, E39	96-9/98	EF1088	Condenser Fan	447
5 Series, E34	88-96	EF6503	Condenser Fan	447
7 Series, E32	88-96	EF6503	Condenser Fan	447
X5, 3.0, 4.4Lt Petrol	00-04	EF6513	Condenser Fan	447
X5, 3.0Lt Diesel	00-04	EF6512	Condenser Fan	447
Chrysler				
Crossfire	03>	EF1337	Radiator Fan	447
PT Cruiser	01-02	EF1159	Condenser Fan	447
Voyager, 4 & 6 cyl	01-02	EF1383	Condenser Fan	447
Voyager, 4 & 6 cyl	01-02	EF1384	Radiator Fan	447
Voyager, V6	96-99	EF1158	Dual Assembly	447
Citroen				
Berlingo	11/02>	EF1367	Radiator Fan	448
C5	00-05	EF1366	Radiator Fan	448

Make & Model	Year	Part No.	Description	Page No.
Daewoo				
Cielo, 1.5Lt	>97	EF1122	Condenser Fan	448
Espero, 1.5Lt	>97	EF1122	Condenser Fan	448
Kalos	05>	EF5146	Radiator Fan	448
Lanos	97>	EF1179	Radiator Fan	448
Lanos	97>	EF1120	Condenser Fan	448
Leganza, 2.0Lt	97-01	EF1178	Condenser Fan	448
Nubira Series I & II, 2.0Lt	97-01	EF1178	Condenser Fan	448
Daihatsu				
Charade	02>	EF3912	Radiator Fan	448
Sirion	97>	EF3911	Radiator Fan	449
Sirion, 1.0Lt		EF3930	Condenser Fan	449
Sirion, 1.3Lt		EF3910	Condenser Fan	449
Doosan				
Solar V Excavator		EF1011	Condenser Fan	449
Ford				
Escape, 3.0Lt, V6	01>	EF5375	Dual Assembly	449
Falcon BF, FG	05>	EF8004	Radiator Fan	449
Falcon BF, FG	05>	EF8005	Radiator Fan	449
Falcon BA II, BF	5/05>	EM5512	Radiator Fan Motor	449
Falcon BA, 6 & 8 cyl	02-04	EF8003	Dual Assembly	449
Falcon AU	99-02	EF8002	Dual Assembly	450
Falcon AU, BA	99-04	EF5528	Radiator Fan Blade	450
Falcon AU, BA	99-04	EM5510	Radiator Fan Motor	450
Falcon AU, BA	99-04	EM5511	Radiator Fan Motor	450
Falcon EL, XH 6 cyl	95-97	EF3034	Dual Assembly	450
Falcon EL	95-97	EM5503	Radiator Fan Motor	450
Falcon EL	95-97	EM5504	Radiator Fan Motor	450
Falcon EF, EL	94-97	EF5515	Radiator Fan Blade	450
Falcon EF	94-95	EF3031	Dual Assembly	450
Falcon EF	94-95	EM5500	Radiator Fan Motor	450
Falcon EA, EB, ED	3/88-8/94	HF9009	Radiator Fan Blade	451
Falcon XG Ute, MPI	3/93-3/96	HF9009	Radiator Fan Blade	451
Festiva WF	4/98 >	EF1121	Condenser Fan	451
Festiva WB	94-98	EF1150	Radiator Fan	451
Festiva, 1.3Lt	88-93	EF1100	Radiator Fan	451
Festiva	88-93	EF1400	Condenser Fan	451
Focus, 2.0Lt	5/05>	EF5385	Radiator Fan	451
Focus, 1.8, 2.0Lt	9/02-4/05	EF1231	Dual Assembly	451
Laser KJ, KN, KQ	1/98>	EF5379	Condenser Fan	451
Laser KN, 1.8Lt	97>	EF5372	Radiator Fan Blade	451

Make & Model	Year	Part No.	Description	Page No.
Laser KN, 1.8Lt	97>	EF5373	Condenser Fan Shroud	451
Laser KJ Liata	95-98	EF5020	Condenser Fan	452
Laser KJ Liata, 1.8Lt	95-98	EF1151	Radiator Fan	452
Laser KJ, 1.8Lt	94-99	EF5371	Radiator Fan Blade	452
Laser KF, KH	90-95	EF1089	Radiator Fan	452
Laser KF, KH, 1.6Lt	90-95	EF1135	Condenser Fan	452
Mondeo HE	2/00-12/00	EF1232	Radiator Fan	452
Mondeo, HA, HB, HC, HD	7/95-2/00	EF1165	Dual Assembly	452
Telstar AR	83-86	EF1097	Radiator Fan	452
Territory, SX, SY 4.0Lt 6 cyl	5/04-4/11	EF8003	Dual Assembly	452
Transit, 2.3Lt Petrol	12/00-10/06	EF1163	Radiator Fan	452
Transit, 2.3Lt Petrol	12/00-10/06	EF1164	Condenser Fan	453
Transit, 2.4Lt Diesel	01>	EF1233	Radiator Fan	453
Hino				
Hino		EM2030	Condenser Fan Motor	453
Hino		EM5460	Radiator Fan Motor	453
Dutro	06>	EF3722	Condenser Fan	453
Dutro	06>	EF3730	Condenser Fan Blade	453
Dutro	06>	EM3700	Radiator Fan Motor	453
FC	97>	EM5592	Condenser Fan Motor	453
Ranger	06>	EM1290	Condenser Fan Motor	453
Ranger	00>	EM1220	Condenser Fan Motor	454
SS Ranger 50 series	00>	EF0670	Condenser Fan Blade	454
Holden				
Adentra VZ, 6 & 8 cyl	04-06	EF1198	Radiator Fan Shroud	457
Adentra VZ, V6	04-06	EF2748	Radiator Fan Motor & Blade	458
Adentra VZ, V6	04-06	EF2747	Radiator Fan Motor & Blade	458
Adentra VZ, V8	04-06	EF2750	Radiator Fan Motor & Blade	458
Adentra VZ, V8	04-06	EF2749	Radiator Fan Motor & Blade	458
Adentra VY, V8	02-04	EF3753	Dual Assembly	458
Adentra VY, V6	02-04	EF3751	Dual Assembly	458
Astra AH	12/04>	EF1251	Radiator Fan Motor & Blade	454
Astra AH	12/04>	EF1253	Radiator Fan Motor & Blade	454
Astra AH	12/04>	EF1257	Condenser Fan Shroud	454
Astra AH	12/04>	EF1255	Condenser Fan Motor & Blade	454
Astra AH	11/04-12/04	EF1256	Radiator Fan Shroud	454
Astra AH	11/04-12/04	EF1250	Radiator Fan Motor & Blade	454
Astra AH	11/04-12/04	EF1252	Radiator Fan Motor & Blade	454
Astra AH	11/04-12/04	EF1254	Condenser Fan Motor & Blade	455
Astra TS, 2.2Lt	00-09	EF1244	Radiator Fan Motor & Blade	455
Astra TS, 2.2Lt	9/00-1/09	EF1243	Radiator Fan Motor & Blade	455

Make & Model	Year	Part No.	Description	Page No.
Astra Convertible Turbo	00-05	EF1243	Radiator Fan Motor & Blade	455
Astra TS, 2.2Lt	9/00-1/09	EF1242	Condenser Fan Motor & Blade	455
Astra TS	98-05	EF1246	Radiator Fan Motor & Blade	455
Astra TS	9/98-11/01	EF2754	Condenser Fan Shroud	455
Astra TS	9/98-11/01	EF2753	Condenser Fan Motor & Blade	455
Astra TS	10/98>	EF1249	Radiator Fan	455
Astra TS	10/98>	EF1130	Condenser Fan	455
Astra TR	9/96-9/98	EF1245	Radiator Fan	455
Astra	>9/98	EF1241	Radiator Fan Motor & Blade	456
Barina TK, 1.6Lt	12/05>	EF5146	Radiator Fan	456
Barina TK, 1.6Lt	12/05>	EF1213	Radiator Fan Shroud	456
Barina XC	9/01-12/05	EF1193	Condenser Fan	456
Barina XC	9/01-12/05	EF1180	Radiator Fan	456
Barina XC, 1.4, 1.8Lt	9/01-12/05	EF1181	Condenser Fan	456
Barina SB	5/94-2/01	EF5144	Radiator Fan	456
Barina SB	5/94-2/01	EF5147	Radiator Fan	456
Barina SB	5/94-2/01	EF1247	Radiator Fan Motor & Blade	456
Barina SB	5/94-2/01	EF5150	Condenser Fan	456
Barina	4/94-2/01	EF1194	Condenser Fan	457
Calibra	6/90-7/97	EF1241	Radiator Fan Motor & Blade	457
Captiva Diesel	3/07>	EF5590	Dual Assembly	457
Captiva Petrol	10/06>	EF5591	Dual Assembly	457
Combo	3/96-9/02	EF1247	Radiator Fan Motor & Blade	456
Combo	3/96-9/02	EF5150	Condenser Fan	456
Commodore VE, V6	8/06>	EF2533	Dual Assembly	457
Commodore VE, V8	8/06>	EF2534	Dual Assembly	457
Commodore VZ, V8	04-06	EF3747	Dual Assembly	457
Commodore VZ, V8	04-06	EF3749	Dual Assembly	457
Commodore VZ, V6	04-06	EF3745	Dual Assembly	457
Commodore VZ, 6 & 8 cyl	04-06	EF1198	Radiator Fan Shroud	457
Commodore VZ, V8	04-06	EF2748	Radiator Fan Motor & Blade	458
Commodore VZ, V8	04-06	EF2747	Radiator Fan Motor & Blade	458
Commodore VZ, V6	04-06	EF2745	Radiator Fan Motor & Blade	458
Commodore VZ, V6	04-06	EF2746	Radiator Fan Motor & Blade	458
Commodore VY, V8	02-04	EF3743	Dual Assembly	458
Commodore VY, V6	02-04	EF3741	Dual Assembly	458
Commodore VY, V8	02-04	EF1197	Radiator Fan Shroud	459
Commodore VY, V6	02-04	EF1196	Radiator Fan Shroud	459
Commodore VY, V8	02-04	EF2743	Radiator Fan Motor & Blade	459
Commodore VY, V8	02-04	EF2744	Radiator Fan Motor & Blade	459
Commodore VY, V6	97>	EF2741	Radiator Fan Motor & Blade	459

Make & Model	Year	Part No.	Description	Page No.
Commodore VY, V6	02-04	EF2742	Radiator Fan Motor & Blade	459
Commodore VX, V6	00-02	EF1195	Dual Assembly	459
Commodore VT, V6	97-00	EF1195	Dual Assembly	459
Commodore VT, V6	97-00	EF1186	Dual Assembly	459
Commodore VT	97-00	EF4180	Radiator Fan Shroud	459
Commodore VT, VX, V8	97-02	EF4180	Radiator Fan Shroud	459
Commodore VT, VX	97-02	EF5850	Radiator Fan Shroud	459
Commodore VT, VX	97-02	EF1710	Radiator Fan Blade	459
Commodore VT, VX, VU, 5.7Lt V8	98>	EM6520	Radiator Fan Motor	459
Commodore VT, V6	97>	EM6430	Radiator Fan Motor	460
Commodore VT, V6	97-00	EM1150	Radiator Fan Motor	460
Commodore VX, VU, V6	97-02	EM1150	Radiator Fan Motor	460
Commodore VT, V6	97-00	EM5280	Radiator Fan Motor	460
Commodore VX, VU, V6	97-02	EM5280	Radiator Fan Motor	460
Commodore VT, V6	97-00	EF2740	Radiator Fan Blade	460
Commodore VX, VU, V8	97-02	EF2740	Radiator Fan Blade	460
Commodore VT, V6	97-00	EF1280	Radiator Fan Blade	460
Commodore VX, VU, V6	97-02	EF1280	Radiator Fan Blade	460
Commodore VT, V6, V8	97-00	EF1990	Radiator Fan Blade	460
Commodore VX, VU, V8	97-02	EF1990	Radiator Fan Blade	460
Commodore VS, V6	4/95-8/97	EF1185	Radiator Fan	460
Commodore VS, V6	4/95-8/97	EF2530	Radiator Fan Shroud	460
Commodore VS, V6	4/95-8/97	EM6331	Radiator Fan Motor	461
Commodore VS, V6	4/95-8/97	EF2660	Radiator Fan Blade	461
Commodore VR, VS, 6 & 8 cyl	7/93-3/97	EF1114	Condenser Fan	461
Commodore VP V8	>3/93	EF1114	Condenser Fan	461
Commodore VN, VP, VR	8/88-4/95	EF1184	Radiator Fan	461
Commodore VN, VP, VR	8/88-4/95	EF2529	Radiator Fan Shroud	461
Commodore VN, VP, VR	8/88-4/95	EM6332	Radiator Fan Motor	461
Commodore VN, VP, VR	8/88-4/95	EF2659	Radiator Fan Blade	461
Commodore VL, 6 cyl	84-86	HF9005M	Radiator Fan Blade	461
Crewman VZ, 6 & 8 cyl	04-06	EF1198	Radiator Fan Shroud	457
Crewman VZ, V6	04-06	EF2748	Radiator Fan Motor & Blade	458
Crewman VZ, V6	04-06	EF2747	Radiator Fan Motor & Blade	458
Crewman VZ, V8	04-06	EF2750	Radiator Fan Motor & Blade	458
Crewman VZ, V8	04-06	EF2749	Radiator Fan Motor & Blade	458
Crewman VY, V8	02-04	EF3753	Dual Assembly	458
Crewman VY, V6	02-04	EF3751	Dual Assembly	458
Cruze JG, 2.0Lt Diesel	6/09	EF1382	Radiator Fan Shroud	461
Cruze JG, 2.0Lt Diesel	6/09	EF1381	Radiator Fan Motor & Blade	461
Cruze JG, 2.0Lt Diesel	6/09	EF1380	Radiator Fan Motor & Blade	462

Make & Model	Year	Part No.	Description	Page No.
Cruze YG	6/02-6/06	EF1350	Condenser Fan	462
Nova LE, LF, 1.6Lt	8/89-10/94	EF1103	Radiator Fan	462
Nova LE, LF, 1.6Lt	8/89-10/94	EF1116	Condenser Fan	462
Rodeo RA03	3/03	EF1190	Condenser Fan	462
Statesman WH, V8	5/00-4/03	EF2743	Radiator Fan Motor & Blade	459
Statesman WH, V8	5/00-4/03	EF2744	Radiator Fan Motor & Blade	459
Statesman VQ, V8	11/91-2/94	EF1114	Condenser Fan	462
Vectra JR, JS, 2.0Lt	6/97>	EF1168	Radiator Fan	462
Vectra JR, JS, 2.0,2.2,2.6Lt	6/97>	EF1142	Radiator Fan Shroud	462
Vectra JR, JS, 2.0Lt	6/97>	EF1169	Condenser Fan	462
Vectra JR, JS, 2.2,2.6Lt	6/97>	EF1140	Condenser Fan Motor & Blade	462
Vectra	9/88-11/95	EF1241	Radiator Fan Motor & Blade	463
Zafira TT, 2.2Lt	6/01-5/06	EF1249	Radiator Fan	463
Zafira TT, 2.2Lt	6/01-5/06	EF1244	Radiator Fan Motor & Blade	463
Zafira TT, 2.2Lt	6/01-5/06	EF1130	Condenser Fan	463
Zafira TT, 2.2Lt	6/01-5/06	EF1242	Condenser Fan Motor & Blade	463
Honda				
Accord Euro	08>	EF1535	Radiator Fan	464
Accord Euro	08>	EF1536	Radiator Fan Shroud	464
Accord Euro	08>	EM8680	Radiator Fan Motor	464
Accord Euro	08>	EM8650	Radiator Fan Motor	464
Accord Euro	08>	EF1537	Radiator Fan Blade	464
Accord Euro	08>	EF1540	Condenser Fan	464
Accord Euro	08>	EF1542	Condenser Fan Shroud	464
Accord Euro	08>	EF1543	Condenser Fan Blade	464
Accord Euro	02>	EF1262	Radiator Fan	464
Accord, V6	08>	EF1545	Radiator Fan	463
Accord, V6	08>	EF1546	Radiator Fan Shroud	463
Accord, V6	08>	EM8671	Radiator Fan Motor	463
Accord, V6	08>	EF1547	Radiator Fan Blade	463
Accord, V6	98-02	EF1147	Radiator Fan	464
Accord	93-97	EF5267	Condenser Fan	465
Accord	93-98	EF5268	Radiator Fan	465
Accord	90-94	EF1102	Radiator Fan	465
Accord	90-94	EF1113	Condenser Fan	465
Accord	86-89	EF1101	Radiator Fan	465
Civic	06>	EF4810	Condenser Fan	465
Civic	06>	EF3120	Condenser Fan Shroud	465
Civic	06>	EM3200	Condenser Fan Motor	465
Civic	06>	EF6350	Condenser Fan Blade	465
Civic, Hybrid	04>	EF1550	Radiator Fan	465

Make & Model	Year	Part No.	Description	Page No.
Civic, Hybrid	04>	EF1552	Radiator Fan Shroud	466
Civic, Hybrid	04>	EM5750	Radiator Fan Motor	466
Civic, Hybrid	04>	EF1557	Radiator Fan Blade	466
Civic Sedan	00-06	EF5269	Radiator Fan	466
Civic Hatchback	00-01	EF5269	Radiator Fan	466
Civic	00-02	EF1146	Condenser Fan	466
Civic	92-3/96	EF1093	Condenser Fan	466
CRV	02-5/05	EF1268	Radiator Fan	466
CRV	02>	EM2575	Radiator Fan Motor	466
CRV	02-5/05	EF1269	Condenser Fan	466
CRV	02>	EM2570	Condenser Fan Motor	466
CRV	97-01	EF1172	Radiator Fan	467
CRV	97-01	EF1173	Condenser Fan	467
Integra	02>	EF1263	Radiator Fan	467
Integra	97-01	EF1173	Condenser Fan	467
Integra	97-99	EF1145	Radiator Fan	467
Integra	95>	EF1267	Radiator Fan	467
Integra	94-01	EF1144	Radiator Fan	467
Jazz	8/08>	EF3182	Condenser Fan	467
Jazz	8/08>	EM8930	Fan Motor	467
Jazz	07>	EM3070	Condenser Fan Motor	467
Legend	96-98	EF1261	Radiator Fan	468
Odyssey	03>	EF1266	Condenser Fan	468
Odyssey	98>	EM5040	Condenser Fan Motor	468
Odyssey	98>	EF2170	Radiator Fan	468
Odyssey		EF1264	Radiator Fan	468
Prelude	96-98	EF1261	Radiator Fan	468
Prelude		EM4650	Radiator Fan Motor	468
S2000		EF2165	Condenser Fan	468
Hyundai				
Accent, Sedan	06-08	EF1377	Condenser Fan	468
Accent, Hatchback	06-08	EF1377	Condenser Fan	468
Accent	6/00>	EF1370	Radiator Fan	469
Accent	6/00>	EF1373	Radiator Fan Shroud	469
Accent	6/00>	EF1376	Radiator Fan Blade	469
Accent	6/00>	EF1200	Condenser Fan	469
Accent	6/00>	EF1374	Condenser Fan Shroud	469
Accent	6/00>	EF1201	Condenser Fan	469
Accent	6/00>	EF1375	Condenser Fan Shroud	469
Accent	6/00>	EF1203	Condenser Fan Blade	469
Elantra MD	6/11>	EF1285	Radiator Fan	469

Make & Model	Year	Part No.	Description	Page No.
Elantra	00-02	EF1277	Radiator Fan	469
Elantra	00-02	EF1276	Condenser Fan	470
Excel	10/94-99	EF1189	Radiator Fan	470
Excel	8/94-9/99	EF1118	Condenser Fan	470
Excel X3, 1.5Lt	8/94-9/99	EF1275	Radiator Fan	470
Excel X3, 1.5Lt	8/94-9/99	EM2202	Radiator Fan Motor	470
Excel X2, 1.5Lt EFI	6/89-7/94	EF1138	Condenser Fan	470
Getz	02>	EF1279	Condenser Fan	470
Grandeur XG30	7/99>	EF1129	Condenser Fan	470
i30, Petrol	10/07>	EF1278	Radiator Fan	470
i30	6/06>	EF1368	Radiator Fan	470
Lantra J2	5/95-6/00	EF1183	Radiator Fan	471
Lantra J2	5/95-5/00	EF1124	Condenser Fan	471
Lantra	5/93-5/95	EF1125	Condenser Fan	471
Lavita	5/01>	EF1202	Condenser Fan	471
RD Coupe	5/96>	EF1124	Condenser Fan	472
RD Coupe	5/96>	EF1183	Radiator Fan	472
S Coupe	7/92-3/96	EF1134	Condenser Fan	471
S Coupe	3/90-7/92	EF1138	Condenser Fan	471
Santa Fe	02-03	EF1271	Radiator Fan	471
Santa Fe	02-03	EF1270	Condenser Fan	471
Sonata	99-02	EF1273	Condenser Fan	471
Sonata EF, 4 cyl 2.0Lt	5/98-9/01	EF1182	Radiator Fan	471
Sonata EF Facelift	4/01>	EF1182	Radiator Fan	471
Sonata EF Facelift	4/01>	EF1129	Condenser Fan	472
Sonata EF, 4 cyl 2.0Lt	5/98-9/01	EF1129	Condenser Fan	472
Sonata I & II, 4 cyl 2.0Lt	7/93-4/98	EF1132	Condenser Fan	472
Trajet	3/00>	EF1182	Radiator Fan	471
Trajet	3/00	EF1129	Condenser Fan	472
Tucson	04>	EF1207	Radiator Fan	472
Isuzu				
CXZ	06>	EM1320	Radiator Fan Motor	472
Isuzu		EM8490	Condenser Fan Motor	472
Iveco				
Iveco		EF0736	Condenser Fan	472
Jeep				
Cherokee	88-96	EF1160	Condenser Fan	473
Grand Cherokee	09-10	EF5540	Condenser Fan	473
Grand Cherokee, V6 4.0Lt	97-01	EF1210	Condenser Fan	473
Kia				
Carnival	9/01>	EF1206	Condenser Fan	473

Make & Model	Year	Part No.	Description	Page No.
Carnival	98-4/01	EF1205	Radiator Fan	473
Carnival		EF1223	Condenser Fan	473
Mentor Series I	97-4/98	EF0039	Condenser Fan	473
Mentor Series I	97-4/98	EM0001	Condenser Fan Motor	473
Optima	9/02>	EF1129	Condenser Fan	473
Optima	2/01-6/01	EF1182	Radiator Fan	473
Rio, 1.6Lt 4 cyl	7/05>	EF1228	Radiator Fan	474
Rio, 1.5Lt 4 cyl	7/05>	EF1224	Radiator Fan	474
Rio, 1.5Lt 4 cyl	1/03-7/05	EF1087	Condenser Fan	474
Rio	01-03	EF1220	Condenser Fan	474
Shuma	1/00-4/01	EF1222	Radiator Fan	474
Shuma	1/00-4/01	EF1221	Condenser Fan	474
Spectra	5/01-6/04	EF1222	Radiator Fan	474
Spectra	5/01-6/04	EF1221	Condenser Fan	474
Sportage Series I & II	12/96-10/97	EF0055	Condenser Fan	474
Land Rover				
Discovery	95-98	EM2321	Condenser Fan Motor	474
Lexus				
ES300	02-03	EF2171	Dual Assembly	474
ES300	99-01	EF2172	Radiator Fan	475
IS200, GXE10R	3/99-10/05	EF2168	Dual Assembly	475
IS300	8/01-10/05	EF2174	Dual Assembly	475
IS350, GSE21R	10/10>	EF2381	Dual Assembly	475
IS350, GSE21R	10/10>	EF2385	Radiator Fan Shroud	475
RX330, MCU38R	4/03-1/06	EF2173	Dual Assembly	475
RX350, GSU35R	2/06-1/09	EF2151	Dual Assembly	475
RX350, GSU35R	2/06-1/09	EF2152	Radiator Fan Shroud	475
RX350, GSU35R	2/06-1/09	EM7140	Radiator Fan Motor	475
RX350, GSU35R	2/06-1/09	EM8250	Radiator Fan Motor	475
RX350, GSU35R	2/06-1/09	EF2155	Radiator Fan Blade	476
RX350, GSU35R	2/06-1/09	EF2157	Radiator Fan Blade	476
RX450H, GLY15R	6/09>	EF2361	Radiator Fan Shroud	476
RX450H, GLY15R	6/09>	EM4780	Radiator Fan Motor	476
RX450H, GLY15R	6/09>	EM5270	Radiator Fan Motor	476
RX450H, GLY15R	6/09>	EF2363	Radiator Fan Blade	476
RX450H, GLY15R	6/09>	EF2365	Radiator Fan Blade	476
Mazda				
121, 1.3Lt	8/94-96	EM0001	Condenser Fan Motor	476
121	91-95	EF1400	Condenser Fan	476
121	88-93	EF1100	Radiator Fan	477
323 Astina BJ, 1.6, 1.8, 2.0Lt	9/98>	EF1148	Radiator Fan	477

Make & Model	Year	Part No.	Description	Page No.
323 Astina BJ, 1.6, 1.8Lt	9/98>	EF5379	Condenser Fan	477
323 Astina BA	7/94-9/98	EF3371	Condenser Fan	478
323 Astina, 1.8Lt Hatch	92>	EM6010	Radiator Fan Motor	478
323 Protégé BJ, 1.6, 1.8, 2.0Lt	98>	EF1148	Radiator Fan	477
323 Protégé BJ, 1.6, 1.8Lt	98>	EF5379	Condenser Fan	477
323 Protégé BA, 1.8Lt	7/94-9/98	EF1149	Condenser Fan	478
323 Protégé BA, 1.8Lt	7/94-9/98	EF1151	Radiator Fan	478
323 BJ	9/98>	EF5381	Radiator Fan	478
323 BJ, 1.8Lt	9/98>	EF5372	Radiator Fan Blade	478
323 BJ, 1.8Lt	9/98>	EF5373	Condenser Fan Shroud	478
323 BA	7/94-9/98	EF1151	Radiator Fan	478
323 BA	7/94-9/98	EF1149	Condenser Fan	478
323, 1.6Lt	90-95	EF1089	Radiator Fan	478
323, 1.6Lt	90-95	EF1135	Condenser Fan	478
626 GF	6/97>	EF5035	Condenser Fan	480
626 V6		EFFA14	Condenser Fan	480
626	83-86	EF1097	Radiator Fan	480
CX-9	12/07>	EF1299	Radiator Fan Shroud	480
CX-9	12/07>	EM5100	Radiator Fan Motor	480
CX-9	12/07>	EM5110	Radiator Fan Motor	480
CX-9	12/07>	EF7040	Radiator Fan Blade	480
CX-9	12/07>	EF7520	Radiator Fan Blade	481
CX-7	11/06>	EF1296	Dual Assembly	481
CX-7	11/06>	EF1295	Radiator Fan Shroud	481
CX-7	11/06>	EM5141	Radiator Fan Motor	481
CX-7	11/06>	EM5340	Radiator Fan Motor	481
CX-7	11/06>	EF1294	Radiator Fan Blade	481
CX-7	11/06>	EF1297	Radiator Fan Blade	481
Mazda 2	9/07>	EF1282	Radiator Fan	477
Mazda 2	9/07>	EF1284	Radiator Fan Shroud	477
Mazda 2	9/07>	EM8310	Radiator Fan Motor	477
Mazda 2	9/07>	EF1293	Radiator Fan Blade	477
Mazda 2 series I & II	12/02-8/07	EF1283	Radiator Fan	477
Mazda 3, 2.0, 2.3Lt	04>	EF5385	Radiator Fan	477
Mazda 3, 2.0, 2.3Lt	04>	EF5388	Radiator Fan Shroud	477
Mazda 6	12/07>	EF2125	Dual Assembly	478
Mazda 6	12/07>	EF2126	Radiator Fan Shroud	479
Mazda 6	12/07>	EM6090	Radiator Fan Motor	479
Mazda 6	12/07>	EM6100	Radiator Fan Motor	479
Mazda 6	12/07>	EF2127	Radiator Fan Blade	479
Mazda 6	12/07>	EF2129	Radiator Fan Blade	479

Make & Model	Year	Part No.	Description	Page No.
Mazda 6	8/02>	EF2169	Dual Assembly	479
Mazda 6, 2.3Lt	02>	EF1281	Dual Assembly	479
Mazda 6	9/04-5/05	EF2120	Dual Assembly	479
Mazda 6	9/04-5/05	EF2122	Radiator Fan Shroud	479
Mazda 6	9/04-5/05	EM5070	Radiator Fan Motor	479
Mazda 6	9/04-5/05	EM5560	Radiator Fan Motor	480
Mazda 6	9/04-5/05	EF2121	Radiator Fan Blade	480
Mazda 6	9/04-5/05	EF2123	Radiator Fan Blade	480
MPV, 3.0Lt	00-03	EF5382	Dual Assembly	481
MPV	96-98	EF5386	Radiator Fan	481
MX5, NB30	10/00-8/05	EF0460	Condenser Fan	481
Premacy 1.8, 2.0Lt	00-03	EF5384	Radiator Fan	482
Premacy 1.8, 2.0Lt	00-03	EF5383	Condenser Fan	482
Tribute, 2.0Lt, 4 cyl	01>	EF5374	Dual Assembly	482
Tribute, 3.0Lt V6	01>	EF5375	Dual Assembly	482
Mercedes Benz				
A Class, A200	04-09	EF1355	Radiator Fan	482
A Class, W168, 1.6Lt	7/97-8/04	EF1336	Radiator Fan	482
B Class, B180, B200	05-09	EF1355	Radiator Fan	482
C Class, W203	00-03	EF1330	Radiator Fan	482
C Class, W202	93-00	EF1331	Radiator Fan	482
C Class, W124	94-97	EF1331	Radiator Fan	482
C Class, C180, C200, 230	93-01	EF1354	Radiator Fan Motor & Blade	482
CLK Class, CLK320	98-01	EF1337	Radiator Fan	483
E Class, W124, W210, E430	96-02	EF1332	Dual Assembly	483
E Class, W124, W210, E320	97-99	EF1332	Dual Assembly	483
E Class, W124, W120, E55, AMG	00-02	EF1332	Dual Assembly	483
E Class, E220, 220E, 230, 230TE, 300TE	84-98	EF1352	Radiator Fan	483
E Class, E200, E230, E240, E280, E320, E430, E55	93-01	EF1354	Radiator Fan Motor & Blade	483
E Class, 300T	6/93-9/96	EF1353	Radiator Fan	483
ML Class, W163, ML320, ML430	00-04	EF1334	Dual Assembly	483
S Class, W220, 6 & 8 cyl	99-02	EF1345	Radiator Fan	483
S Class, W140	92-99	EF1344	Condenser Fan	483
S Class, W124, W126	85-91	EF6540	Condenser Fan	483
S Class, C126	81-91	EF6540	Condenser Fan	483
SLK320	98-01	EF1337	Radiator Fan	483
Sprinter		EF1342	Radiator Fan	484
Sprinter	4/01>	EF1351	Radiator Fan Blade	484
Vito		EF1342	Radiator Fan	484
Vito	04>	EF1349	Radiator Fan	484
Vito, W638	98-03	EF1341	Radiator Fan	484

Make & Model	Year	Part No.	Description	Page No.
W638, MB100	98-03	EF1341	Radiator Fan	483
W201 190	9/86-8/93	EF1353	Radiator Fan	484
W170, W202, C230, SLK200, SLK230K	96-04	EF1162	Radiator Fan	484
W124, W126, 260E, 300E	86-89	EF1342	Radiator Fan	484
W126, 300E, 350E	86-89	EF1343	Radiator Fan	484
W124, 200E, 230E, 200D, 250D, 300E	12/85>	EF1353	Radiator Fan	484
W120, E320	00-02	EF1338	Radiator Fan	484
Mini				
Cooper R56, 1.6Lt	3/07>	EF6509	Radiator Fan	485
Cooper, 1.6Lt	01-04	EF6510	Radiator Fan	485
Mitsubishi				
380	10/05>	EF1291	Radiator Fan	485
L400 WA Starwagon	6/94	EF1170	Dual Assembly	485
Lancer CG-CH	6/00-9/07	EF1292	Dual Assembly	485
Lancer CE	5/96-02	EF1175	Radiator Fan	485
Lancer CE	5/96-02	EF1171	Condenser Fan	485
Lancer CC	6/92-4/96	EF1174	Radiator Fan	485
Lancer CC	6/92-4/96	EF5149	Condenser Fan	485
Magna TJ, TL	8/00>	EM3870	Radiator Fan Motor	486
Magna TJ	8/00>	EM6321	Radiator Fan Motor	486
Magna TJ	8/00-6/03	EM6311	Radiator Fan Motor	486
Magna TE, TF, TH, TJ	2/96>	EF1119	Condenser Fan	486
Magna TS	3/94-3/97	EF1288	Radiator Fan Blade	486
Magna TR, TS, 4 cyl	91-3/97	EM7150	Condenser Fan Motor	486
Magna TS, V6	3/94-3/97	EM7150	Condenser Fan Motor	486
Magna TN, TP	7/87-7/91	EM9000	Condenser Fan Motor	486
Magna TM, TN	7/85-7/91	EM4580	Radiator Fan Motor	486
Mirage CE	5/96-02	EF1175	Radiator Fan	485
Mirage CE	5/96-02	EF1171	Condenser Fan	485
Nimbus UG	99>	EF2178	Radiator Fan	486
Pajero NM, NP, 3.5Lt, V6 Petrol, 2.8, 3.2Lt, Diesel	5/00>	EF3703	Condenser Fan	486
Pajero NJ, NK, NL, 3.0, 3.5Lt V6 Petrol, 2.8Lt Diesel	11/93-6/00	EF2182	Condenser Fan	487
Pajero NJ, NK, NL	11/93>	EM7121	Condenser Fan Motor	487
Triton MK, 3.0Lt V6	01-03	EF2162	Condenser Fan	487
Verada KE, KF, KH, KJ	2/96>	EF1119	Condenser Fan	487
Nissan				
Maxima A33, Infiniti 30	00-01	EF1153	Dual Assembly	487
Maxima A32	11/94-12/99	EF1152	Dual Assembly	487
Micra	93>	EF1314	Radiator Fan	487
Micra	93>	EF1303	Condenser Fan	487

Make & Model	Year	Part No.	Description	Page No.
Murano, Z50, 3.5Lt V6	7/05>	EF1302	Dual Assembly	487
Patrol		EF1306	Radiator Fan Blade	488
Pulsar N16	7/00>	EF5151	Dual Assembly	488
Pulsar N14, N15, 1.6, 2.0Lt	>9/00	EF1127	Condenser Fan	488
Pulsar N14, 1.6, 2.0Lt	5/00>	EF5005	Radiator Fan	488
Pulsar N12	4/86-6/87	EF1115	Condenser Fan	488
Terrano, 2.4Lt Petrol, 2.7Lt Diesel	98-99	EM0001	Condenser Fan Motor	488
Terrano		EF1306	Radiator Fan Blade	488
Tiida C11	10/06>	EF1307	Radiator Fan	488
X-Trail	9/01>	EF1301	Dual Assembly	488
Peugeot				
206	98>	EF1209	Radiator Fan	489
306	4/97-12/02	EF1166	Dual Assembly	489
306	95-3/97	EF1167	Dual Assembly	489
307	4/01>	EF1212	Radiator Fan	489
406	97-02	EF1211	Dual Assembly	489
Porsche				
911, 3.4, 3.6Lt	97-04	EF1428	Radiator Fan Motor & Blade	489
Boxster	96-04	EF1428	Radiator Fan Motor & Blade	489
Cayenne	8/03-8/10	EF1219	Radiator Fan Motor & Blade	489
Cayenne	02-07	EF1426	Radiator Fan Motor & Blade	489
Cayenne	02-07	EF1425	Radiator Fan Motor & Blade	489
Proton				
Persona, 1.5, 1.6Lt	96>	EF5149	Condenser Fan	490
Wira, 1.5, 1.6Lt	96>	EF5149	Condenser Fan	490
Saab				
9-5	6/97-1/09	EF1452	Radiator Fan Motor & Blade	490
9-5	6/97-1/09	EF1454	Radiator Fan Motor & Blade	490
Seat				
Cordoba	93-02	EF1208	Radiator Fan Motor & Blade	490
Cordoba	93-02	EF1313	Radiator Fan Motor & Blade	490
Cordoba	2/93-02	EF1218	Radiator Fan Blade	490
Cordoba	93-02	EF1420	Radiator Fan Motor & Blade	490
Cordoba	93-02	EF1434	Radiator Fan Motor & Blade	490
Cordoba	93-99	EF1217	Radiator Fan Motor & Blade	490
Ibiza	93-02	EF1434	Radiator Fan Motor & Blade	490
Ibiza	98-99	EF1208	Radiator Fan Motor & Blade	490
Ibiza	93-99	EF1217	Radiator Fan Motor & Blade	490
Ibiza	91-99	EF1313	Radiator Fan Motor & Blade	490
Ibiza	93-97	EF1420	Radiator Fan Motor & Blade	490
Ibiza II	3/93-99	EF1218	Radiator Fan Blade	490

Make & Model	Year	Part No.	Description	Page No.
Toledo	91-99	EF1313	Radiator Fan Motor & Blade	490
Toledo	91-99	EF1420	Radiator Fan Motor & Blade	490
Ssangyong				
Musso		EF1342	Radiator Fan Motor & Blade	490
Subaru				
Forester	03-05	EF1325	Dual Assembly	491
Forester	03-05	EF1326	Dual Assembly	491
Forester	99-02	EF1323	Condenser Fan	491
Forester, 2.0Lt	99-02	EF1324	Radiator Fan	491
Impreza, 2.0Lt	02-03	EF1327	Radiator Fan	491
Impreza, 2.0Lt	02-03	EF1328	Condenser Fan	491
Impreza	02>	EF1322	Radiator Fan	491
Impreza	98>	EF1319	Radiator Fan	491
Impreza	98>	EF1329	Condenser Fan	491
Impreza, 1.8Lt	>97	EF1156	Radiator Fan	492
Legacy	98-03	EF1321	Radiator Fan	492
Legacy	98-03	EF1320	Condenser Fan	492
Liberty	98-03	EF1321	Radiator Fan	492
Liberty	98-03	EF1320	Condenser Fan	492
Liberty, 4 cyl	00-02	EF1316	Radiator Fan	492
Liberty, 4 cyl	02-04	EF1315	Condenser Fan	492
Liberty, 2.2Lt	94-98	EF1318	Radiator Fan	492
Liberty, 2.2Lt	94-98	EF1317	Condenser Fan	492
Suzuki				
Baleno, 1.6Lt	4/95-11/01	EF3353	Radiator Fan	492
Baleno	95-98	EF1157	Condenser Fan	492
Grand Vitara	06>	EF2320	Dual Assembly	493
Grand Vitara	06>	EF2321	Radiator Fan Shroud	493
Grand Vitara	06>	EM9591	Radiator Fan Motor	493
Grand Vitara	06>	EM9602	Radiator Fan Motor	493
Grand Vitara	06>	EF2322	Radiator Fan Blade	493
Grand Vitara	06>	EF2149	Radiator Fan Blade	493
Ignis		EF2325	Radiator Fan	493
Jimny	98>	EF1157	Condenser Fan	492
Liana, 2.4Lt	11/01-3/04	EF3352	Condenser Fan	493
Swift EZ, Series I & II	2/05>	EF2326	Radiator Fan	493
Swift EZ, Series I & II	2/05>	EF2327	Radiator Fan Shroud	493
Swift EZ, Series I & II	2/05>	EM8310	Radiator Fan Motor	494
Vitara TD01, 5 Door P/S	95>	EF2183	Condenser Fan	494
Toyota				
4 Runner LN130R, RN130R, VZN130R	4/89-6/96	EM1810	Condenser Fan Motor	494

Make & Model	Year	Part No.	Description	Page No.
Aurion, GSV40R	10/06>	EF2141	Radiator Fan Shroud	494
Aurion, GSV40R	10/06>	EM8240	Radiator Fan Motor	494
Aurion, GSV40R	10/06>	EF2145	Radiator Fan Blade	494
Avalon MCX10	7/00-3/06	EF2184	Condenser Fan	494
Avalon MCX10	7/00-3/06	EF1780	Condenser Fan Shroud	494
Avalon MCX10	7/00-3/06	EM0094	Condenser Fan Motor	494
Avalon MCX10	7/00-3/06	EF2610	Condenser Fan Blade	495
Avensis Verso ACM20R, ACM21R	5/01>	EF2304	Radiator Fan Shroud	495
Avensis Verso ACM20R, ACM21R	12/01-11/10	EM2312	Radiator Fan Motor	495
Avensis Verso ACM20R, ACM21R	12/01-11/10	EM7725	Radiator Fan Motor	495
Avensis Verso ACM20R, ACM21R	12/01-11/10	EF2312	Radiator Fan Blade	495
Avensis Verso ACM20R, ACM21R	12/01-11/10	EF2303	Radiator Fan Blade	495
Camry AHV40R, Hybrid	2/10>	EF2355	Radiator Fan Shroud	495
Camry AHV40R, Hybrid	2/10>	EM7680	Radiator Fan Motor	495
Camry AHV40R, Hybrid	2/10>	EF2354	Radiator Fan Blade	495
Camry AHV40R, Hybrid	2/10>	EF2357	Radiator Fan Blade	495
Camry ACV40R	7/06-1/12	EF2134	Dual Assembly	496
Camry ACV40R	7/06-1/12	EF2138	Radiator Fan Shroud	496
Camry ACV40R	7/06-1/12	EM5960	Radiator Fan Motor	496
Camry ACV40R	7/06-1/12	EM9720	Radiator Fan Motor	496
Camry ACV40R	7/06-1/12	EF2135	Radiator Fan Blade	496
Camry ACV40R	7/06-1/12	EF2137	Radiator Fan Blade	496
Camry ACV36, 4 cyl	9/02-6/06	EF2199	Radiator Fan Shroud	496
Camry ACV36, 4 cyl	9/02-6/06	EM2131	Radiator Fan Motor	496
Camry ACV36, 4 cyl	9/02-6/06	EM2133	Radiator Fan Motor	496
Camry ACV36, 4 cyl	9/02-6/06	EF2133	Radiator Fan Blade	496
Camry ACV36, 4 cyl	9/02-6/06	EF2131	Radiator Fan Blade	497
Camry MCV36, V6	9/02-6/06	EF2199	Radiator Fan Shroud	496
Camry MCV36, V6	9/02-6/06	EM2131	Radiator Fan Motor	496
Camry MCV36, V6	9/02-6/06	EM2133	Radiator Fan Motor	496
Camry MCV36, V6	9/02-6/06	EF2133	Radiator Fan Blade	496
Camry MCV36, V6	9/02-6/06	EF2131	Radiator Fan Blade	497
Camry MCV20R, V6	8/97-8/02	EM0150	Radiator Fan Motor	497
Camry MCV20R, V6	8/97-8/02	EM5311	Radiator Fan Motor	497
Camry MCV20R, V6	8/97-8/02	EF2186	Condenser Fan	497
Camry MCV20R, V6 AVT	8/97-8/02	EF2187	Condenser Fan	497
Camry MCV20R, V6	8/97-8/02	EF2160	Condenser Fan Shroud	497
Camry MCV20R, V6	8/97-8/02	EM2521	Condenser Fan Motor	497
Camry MCV20R, V6	8/97-8/02	EM5250	Condenser Fan Motor	497
Camry SXV20R, 4 cyl	8/97-8/02	EF2191	Radiator Fan	497
Camry SXV20R, 4 cyl	8/97-8/02	EM5311	Radiator Fan Motor	497

Make & Model	Year	Part No.	Description	Page No.
Camry SXV20R, 4 cyl	8/97-8/02	EF2188	Condenser Fan	497
Camry SXV20R, 4 cyl	8/97-8/02	EM5250	Condenser Fan Motor	497
Camry SXV20R, 4 cyl	8/97-8/02	EF2179	Condenser Fan Shroud	498
Camry SDV10, 4 cyl	11/92-7/97	EM0065	Radiator Fan Motor	498
Camry SDV10, 4 cyl	11/92-7/97	EF2185	Condenser Fan	498
Camry SDV10, 4 cyl	11/92-7/97	EF0480	Condenser Fan Shroud	498
Camry SDV10, 4 cyl	11/92-7/97	EM0070	Condenser Fan Motor	498
Camry SDV10, 4 cyl	11/92-7/97	EF1980	Condenser Fan Blade	498
Camry SV22	9/89-2/93	EF2159	Radiator Fan Shroud	498
Camry SV21	5/87-2/93	EF1104	Radiator Fan	498
Camry SV21, SV22	5/87-2/93	EM7180	Radiator Fan Motor	498
Celica ZTZ231R, 1.8Lt	11/99-3/06	EF2198	Dual Assembly	498
Celica ZTZ231R, 1.8Lt	11/99-3/06	EF3770	Radiator Fan Blade	499
Celica ST204, 205	2/94	EM7723	Radiator Fan Motor	499
Coaster		EM0372	Condenser Fan Motor	499
Coaster		EM0860	Condenser Fan Motor	499
Corolla ZRE152R	5/07>	EF1890	Radiator Fan	499
Corolla ZRE152R	5/07>	EF1891	Radiator Fan Shroud	499
Corolla ZRE152R	5/07>	EF1893	Radiator cover	499
Corolla ZRE152R	5/07>	EM1890	Radiator Fan Motor	499
Corolla ZRE152R	5/07>	EF1892	Radiator Fan Blade	499
Corolla ZZE122R	12/01>	EF2872	Radiator Fan	499
Corolla ZZE122R	12/01>	EF2181	Radiator Fan Shroud	500
Corolla ZZE122R	12/01>	EM3540	Radiator Fan Motor	500
Corolla ZZE122R	12/01>	EF2180	Radiator Fan Blade	500
Corolla AE112	8/98-9/01	EF2194	Radiator Fan	500
Corolla AE112	8/98-9/01	EF1520	Radiator Fan Shroud	500
Corolla AE112	8/98>	EM7723	Radiator Fan Motor	500
Corolla AE112	8/98-9/01	EF0420	Radiator Fan Blade	500
Corolla AE111, AE112	8/98-9/01	EF5102	Condenser Fan	500
Corolla AE101, AE102	2/94-8/99	EF1187	Condenser Fan	500
Corolla AE90, AE92, AE93	2/89-7/94	EF1103	Radiator Fan	500
Corolla AE90, AE92, AE93, AE94, AE95, AE96	2/89-8/95	EF1116	Condenser Fan	501
Corolla	89-92	EF1137	Condenser Fan	501
Echo NCP10, 1.3, 1.5Lt, NCP12	10/99>	EF2177	Radiator Fan	501
Echo NCP10R, NCP12R, NCP13R	3/99>	EM2303	Radiator Fan Motor	501
Echo NCP10R, NCP12R, NCP13R	3/99>	EM2312	Radiator Fan Motor	501
Hiace LH103, LH113, RZH103, RZH113	8/93-7/98	EF2197	Condenser Fan	501
Hiace LH103, LH113, RZH103, RZH103, RZH113, RZH125	8/93-7/98	EM2196	Condenser Fan Motor	501
Hiace KDH200R, KDH201R, KDH220R, KDH221R, KDH222R, KZH223R	3/05>	EF2140	Auxiliary Radiator Fan	501

Make & Model	Year	Part No.	Description	Page No.
Hiace KDH200R, KDH201R, KDH220R, KDH221R, KDH222R, KDH223R	3/05>	EF2142	Auxiliary Radiator Fan Shroud	501
Hiace KDH200R, KDH201R, KDH220R, KDH221R, KDH222R, KDH223R	3/05>	EM7780	Auxiliary Radiator Fan Motor	501
Hiace KDH200R, KDH201R, KDH220R, KDH221R, KDH222R, KDH223R	3/05>	EF2143	Auxiliary Radiator Blade	502
Hiace KDH200R, KDH201R, KDH220R, KDH221R, KDH222R, KDH223R	3/05>	EF2175	Radiator Fan Shroud	502
Hiace KDH200R, KDH201R, KDH220R, KDH221R, KDH222R, KDH223R	3/05>	EM4780	Radiator Fan Motor	502
Hiace KDH200R, KDH201R, KDH220R, KDH221R, KDH222R, KDH223R	3/05>	EM4810	Radiator Fan Motor	502
Hiace RZH103, RZH113	8/93-7/98	EF2197	Condenser Fan	501
Hiace RZH103, RZH103, RZH113, RZH125	8/93-7/98	EM2196	Condenser Fan Motor	501
Hiace TRH201R, TRH221R, TRH2213R	3/05>	EF2175	Radiator Fan Shroud	502
Hiace TRH201R, TRH221R, TRH2213R	3/05>	EM4780	Radiator Fan Motor	502
Hiace TRH201R, TRH221R, TRH2213R	3/05>	EM4810	Radiator Fan Motor	502
Kluger GSU40R, GSU45R	8/07>	EF2340	Dual Assembly	502
Kluger GSU40R, GSU45R	8/07>	EF2341	Radiator Fan Shroud	502
Kluger GSU40R, GSU45R	8/07>	EM9220	Radiator Fan Motor	502
Kluger GSU40R, GSU45R	8/07>	EM9221	Radiator Fan Motor	502
Kluger GSU40R, GSU45R	8/07>	EF2342	Radiator Fan Blade	502
Kluger GSU40R, GSU45R	8/07>	EF2343	Radiator Fan Blade	502
Kluger MCU28	11/03-7/07	EF2196	Dual Assembly	503
Kluger MCU28	11/03-7/07	EF2302	Radiator Fan Shroud	503
Kluger MCU28	11/03-7/07	EM7724	Radiator Fan Motor	503
Kluger MCU28	11/03-7/07	EF2300	Radiator Fan Blade	503
Kluger MCU28	11/03-7/07	EF2301	Radiator Fan Blade	503
Landcruiser 200 Series, VDJ200R, UZJ200R	11/07>	EF5490	Condenser Fan	503
Landcruiser 200 Series, VDJ200R, UZJ200R	11/07>	EF5492	Condenser Fan Shroud	503
Landcruiser 200 Series, VDJ200R, UZJ200R	11/07>	EF5499	Condenser Fan Blade	503
Landcruiser 200 Series, VDJ200R, UZJ200R	11/07>	EM3360	Radiator Fan Motor	503
Landcruiser 100 Series, FZJ105, UZJ100 V8	1/98-10/03	EF2190	Condenser Fan	503
Landcruiser 100 Series, FZJ105, UZJ100 V8	1/98-10/03	EM2130	Condenser Fan Motor	504
Lexcen VR, VS	6/93-5/97	EF1114	Condenser Fan	504
MR2 ZZW30	8/00>	EM5330	Condenser Fan Motor	504
MR2 SW20	12/91-8/00	EM7723	Radiator Fan Motor	504
Paseo	96>	EM2420	Condenser Fan Motor	504
Paseo EL54	8/95-7/99	EF2480	Condenser Fan	504
Paseo EL54	8/95-7/99	EF1290	Condenser Fan Shroud	504
Paseo EL54	8/95-7/99	EM2440	Condenser Fan Motor	504

Make & Model	Year	Part No.	Description	Page No.
Paseo EL54	8/95-7/99	EF2130	Condenser Fan Blade	504
Prius ZVW30	4/09>	EF2351	Radiator Fan Shroud	504
Prius ZVW30	4/09>	EM8980	Radiator Fan Motor	505
Prius ZVW30	4/09>	EM8990	Radiator Fan Motor	505
Prius ZVW30	4/09>	EF2352	Radiator Fan Blade	505
Prius ZVW30	4/09>	EF2353	Radiator Fan Blade	505
Prius NHW20R	11/03-6/09	EF2484	Dual Assembly	505
Prius NHW20R	11/03-6/09	EF2485	Radiator Fan Shroud	505
Prius NHW20R	11/03-6/09	EM7250	Radiator Fan Motor	505
Prius NHW20R	11/03-6/09	EM7420	Radiator Fan Motor	505
Prius NHW20R	11/03-6/09	EF2571	Radiator Fan Blade	505
Prius NHW20R	11/03-6/09	EF2572	Radiator Fan Blade	505
Rav4 ACA38R	3/10>	EM2303	Radiator Fan Motor	506
Rav4 ACA38R	3/10>	EM2312	Radiator Fan Motor	506
Rav4 GSA33R, 3.5Lt V6	10/07>	EF2338	Dual Assembly	506
Rav4 GSA33R, 3.5Lt V6	10/07>	EF2335	Radiator Fan Shroud	506
Rav4 GSA33R, 3.5Lt V6	10/07>	EF2336	Radiator cover	506
Rav4 GSA33R, 3.5Lt V6	10/07>	EF2338J	Dual Assembly	506
Rav4 ACA33R	11/05>	EF2305	Dual Assembly	506
Rav4 ACA33R	11/05>	EF2309	Radiator Fan Shroud	506
Rav4 ACA33R	11/05>	EF2319	Radiator Cover	506
Rav4 ACA33R	11/05>	EM9170	Radiator Fan Motor	506
Rav4 ACA33R	11/05>	EF2313	Radiator Fan Blade	507
Rav4 ACA33R	11/05>	EF2314	Radiator Fan Blade	507
Rav4 ACA20, ACA21	5/00>	EF2193	Radiator Fan	507
Rav4 ACA20, ACA21	5/00>	EM7320	Radiator Fan Motor	507
Rav4 ACA20, ACA21	5/00>	EF2334	Radiator Fan Blade	507
Rav4 ACA20, ACA21	5/00>	EF2337	Radiator Fan Blade	507
Rav4 ACA20, ACA21	5/00>	EF2192	Condenser Fan	507
Rav4 ACA20, ACA21	5/00>	EF2308	Condenser Fan Shroud	507
Rav4 SXA10R, SXA11R	7/94-9/00	EF2195	Radiator Fan	507
Rav4 SXA10R, SXA11R	7/94-9/00	EF1760	Radiator Fan Shroud	507
Rav4 SXA10R, SXA11R	7/94-9/00	EM0620	Radiator Fan Motor	508
Rav4 SXA10R, SXA11R	7/94-9/00	EM9660	Radiator Fan Motor	508
Rav4 SXA10R, SXA11R	7/94-9/00	EF0730	Radiator Fan Blade	508
Rav4 SXA10R, SXA11R, M/T	7/94-9/00	EF2189	Condenser Fan	508
Rav4 SXA10R, SXA11R, M/T	7/94-9/00	EF2307	Condenser Fan Shroud	508
Rav4 SXA10R, SXA11R, A/T	7/94-9/00	EF2360	Condenser Fan	508
Rav4 SXA10R, SXA11R, A/T	7/94-9/00	EF2306	Condenser Fan Shroud	508
Rav4 SXA10R, SXA11R, A/T	7/94-9/00	EM7200	Condenser Fan Motor	508
Rav4 SXA10R, SXA11R, A/T	7/94-9/00	EF2590	Condenser Fan Blade	508

Make & Model	Year	Part No.	Description	Page No.
Rukus AZE15R	5/10>	EF2395	Radiator Fan Shroud	508
Rukus AZE15R	5/10>	EM8560	Radiator Fan Motor	509
Rukus AZE15R	5/10>	EF2392	Radiator Fan Blade	509
Rukus AZE15R	5/10>	EF2393	Radiator Fan Blade	509
Starlet EP91	11/96-8/99	EF2871	Radiator Fan	509
Starlet EP91	11/96-8/99	EF2870	Condenser Fan	509
Starlet EP91	11/96-8/99	EF1560	Condenser Fan Shroud	509
Starlet EP91	11/96-8/99	EM2330	Condenser Fan Motor	509
Starlet EP91	11/96-8/99	EF2580	Condenser Fan Blade	509
Tarago GSR50R, V6	2/07>	EF2330	Dual Assembly	509
Tarago GSR50R, V6	2/07>	EF2331	Radiator Fan Shroud	509
Tarago GSR50R, V6	2/07>	EM2319	Radiator Fan Motor	510
Tarago GSR50R, V6	2/07>	EM2320	Radiator Fan Motor	510
Tarago GSR50R, V6	2/07>	EF2332	Radiator Fan Blade	510
Tarago GSR50R, V6	2/07>	EF2333	Radiator Fan Blade	510
Tarago ACR50R	3/06>	EF2315	Dual Assembly	510
Tarago ACR50R	3/06>	EF2316	Radiator Fan Shroud	510
Tarago ACR50R (Tow pack upgrade)	3/06>	EF2324	Radiator Fan Shroud	510
Tarago ACR50R	3/06>	EM2303	Radiator Fan Motor	510
Tarago ACR50R	3/06>	EM2312	Radiator Fan Motor	510
Tarago ACR50R (Tow pack upgrade)	3/06>	EM2317	Radiator Fan Motor	510
Tarago ACR50R (Tow pack upgrade)	3/06>	EM2318	Radiator Fan Motor	511
Tarago ACR50R	3/06>	EF2317	Radiator Fan Blade	511
Tarago ACR50R	3/06>	EF2318	Radiator Fan Blade	511
Tarago ACR50R	3/06>	EF2231	Radiator Cover	511
Tarago ACR30R	6/00-2/06	EF2311	Radiator Fan Shroud	511
Tarago ACR30R	6/00-2/06	EM2312	Radiator Fan Motor	511
Tarago ACR30R	6/00-2/06	EM2303	Radiator Fan Motor	511
Tarago ACR30R	6/00-2/06	EF2303	Radiator Fan Blade	511
Tarago ACR30R	6/00-2/06	EF2312	Radiator Fan Blade	511
Townace KR42R	2/97-2/05	EM2521	Radiator Fan Motor	511
Yaris NCP90R, NCP91R, NCP93R	11/05>	EF2545	Radiator Fan	512
Yaris NCP90R, NCP91R, NCP93R	11/05>	EM9130	Radiator Fan Motor	512
Volkswagen				
Beetle	00>	EF1176	Dual Assembly	512
Beetle	00>	EM1176	Radiator Fan Motor & Blade	512
Beetle	00>	EM1177	Radiator Fan Motor & Blade	512
Beetle	10/99-6/04	EF1216	Radiator Fan Motor & Blade	512
Bora	10/98-5/05	EF1216	Radiator Fan Motor & Blade	512
Bora	12/99-7/01	EF1237	Dual Assembly	512
Bora	12/99-7/01	EF1238	Radiator Fan	512

Make & Model	Year	Part No.	Description	Page No.
Caddy II	11/98-5/97	EF1434	Radiator Fan Motor & Blade	512
Caddy	8/82-5/97	EF1217	Radiator Fan Motor & Blade	513
Caravelle T5	03-09	EF1424	Radiator Fan Motor & Blade	513
Caravelle T5	03-09	EF1422	Radiator Fan Motor & Blade	513
Caravelle T4	90-03	EF1431	Radiator Fan Motor & Blade	513
Golf IV Cabriolet	6/98-6/02	EF1423	Radiator Fan Motor & Blade	513
Golf IV	8/97-6/05	EF1216	Radiator Fan Motor & Blade	513
Golf III	91-98	EF1423	Radiator Fan Motor & Blade	513
Golf II, III & IV	90-91	EF1434	Radiator Fan Motor & Blade	513
Golf II	90-92	EF1208	Radiator Fan Motor & Blade	513
Golf II	90-92	EF1217	Radiator Fan Motor & Blade	514
Golf II, 1.8Lt	8/87-7/90	EF1430	Radiator Fan Motor & Blade	513
Golf I & II	83-93	EF1218	Radiator Fan Motor & Blade	514
Jetta	1/84-12/91	EF1218	Radiator Fan Motor & Blade	514
Jetta II	1/84-12/91	EF1434	Radiator Fan Motor & Blade	514
Jetta	8/84-7/90	EF1430	Radiator Fan Motor & Blade	514
Multivan T5	03-09	EF1424	Radiator Fan Motor & Blade	514
Multivan T5	03-09	EF1422	Radiator Fan Motor & Blade	514
Multivan	4/03-11/09	EF1219	Radiator Fan Motor & Blade	514
Passat	91-97	EF1423	Radiator Fan Motor & Blade	514
Passat	91-97	EF1420	Radiator Fan Motor & Blade	514
Passat	91-97	EF1434	Radiator Fan Motor & Blade	514
Passat	1/86-8/96	EF1218	Radiator Fan Motor & Blade	515
Passat	8/85-8/96	EF1217	Radiator Fan Motor & Blade	515
Polo	83-93	EF1218	Radiator Fan Motor & Blade	515
Polo III	12/03-5/08	EF1227	Radiator Fan Motor & Blade	515
Polo III	7/95-9/01	EF1216	Radiator Fan Motor & Blade	515
Touareg	9/03-5/10	EF1219	Radiator Fan Motor & Blade	515
Touareg	02-09	EF1425	Radiator Fan Motor & Blade	515
Touareg	02-09	EF1426	Radiator Fan Motor & Blade	515
Transporter T5	4/03-11/09	EF1219	Radiator Fan Motor & Blade	515
Transporter T5	03>	EF1422	Radiator Fan Motor & Blade	515
Transporter T5	03>	EF1424	Radiator Fan Motor & Blade	515
Transporter T4	98>	EF1214	Dual Assembly	516
Transporter T4	90-97	EF1215	Dual Assembly	516
Transporter T4	90>	EF1431	Radiator Fan Motor & Blade	516
Vento	95-97	EF1423	Radiator Fan Motor & Blade	516
Vento	95-97	EF1434	Radiator Fan Motor & Blade	516

Straight & Skew Blade Fans

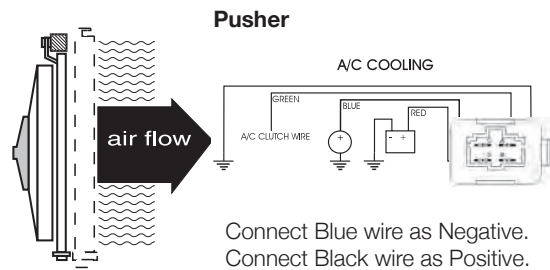

Reversible Fans

These fans can be installed as pusher or puller simply by flipping the fan blade over and reversing the wire. Refer to fan description to determine standard set-up ex factory.

Standard Assemblies

These assemblies are manufactured with the blue wire as positive (+) in a puller mode. In the pusher mode the black wire will be positive (+).

See accompanying illustrations.

Note:

For new installations, additional parts comprising of a Wiring Loom, Relays & Mount legs may be required.

Contact sales staff for parts that suit your needs.

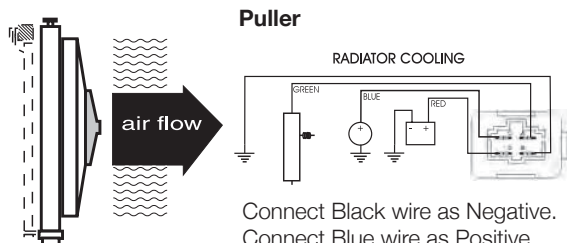

Straight Blade Type

Skewed Blade Type

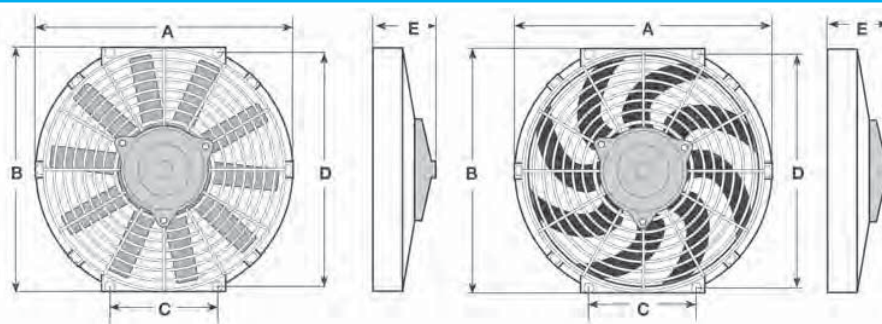

Recommendations for the use of an Axial Fan

To maximise the life of any axial fan a good quality power supply must be provided, Power supply must be stable and where necessary a voltage rectifier used to ensure that a voltage RIPPLE does not occur at the fan. A voltage ripple greater than 1% could create excess overheating of the motor brushes; in turn this overheating may significantly reduce the life or even damage the fan assembly.

A suitable external fuse for each fan is needed to interrupt power supply. This is protection for the wiring harness and protects against restrictions of the fan assembly.

It is the customer's responsibility to adequately protect the system and the axial fan against overload conditions or accidental blade restrictions.

Jayair Universal Fans

Jayair Fan Measuring Legend

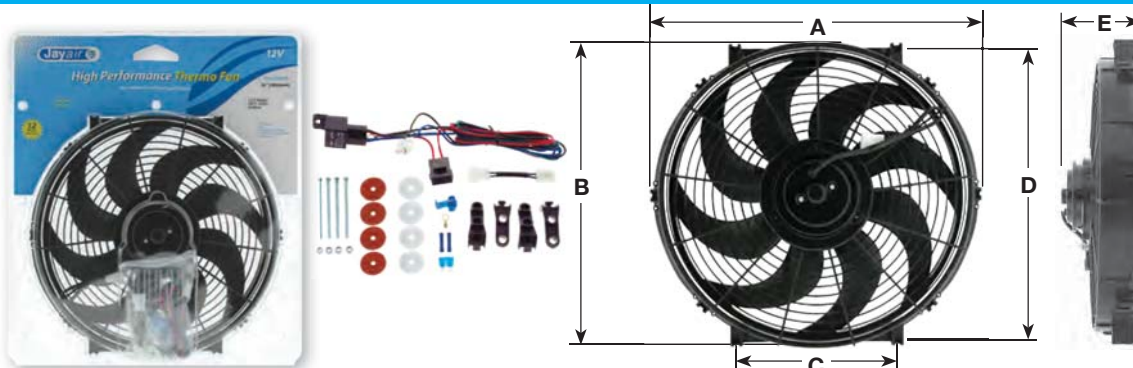

Part No.	Description	Amps	Watts	CFM	m3/h	A	B	C	D	E
EF9528	10" 12V Skew Blade/Reversible	4.5	54	833	1416	270	288	195	195	62
EF9532	12" 12V Skew Blade/Reversible	5	60	1200	2040	305	326	155	285	62
EF9657	14" 12V Skew Blade/Reversible	9.5	114	2050	3480	352	376	178	328	87
EF9634	16" 12V Skew Blade/Reversible	13	156	2009	3411	425	395	208	382	105

Key features for ebm-papst S1G & W3G axial assemblies

- Brushless extended life motors
 - nominal life of 25,000hrs+
- Very low noise operation
- Full speed 12V & 24V operation
- Variable speed operation
- Reverse battery & locked rotor protection
- Over temperature protection
- Steel and plastic variations
- Low EMC/RFI interference
- Enhanced temperature range (-40°C to +85°C)
- 2 year warranty period

ebm-papst fans are not reversible. Applications must be determined for the correct fan choice.

ebm-papst S1G Series

(Steel Blade & Basket Grille)

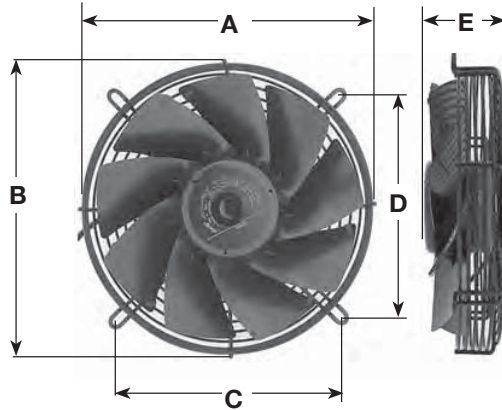

Part No.	Description	Amps	Watts	CFM	m3/h	A	B	C	D	E
EF7996	10" 12V Pusher/S1G250-AI79-50	6.0	72	571	970	279	279	212	212	74
EF7997	10" 12V Puller/S1G250-AH79-50	6.0	72	571	970	279	279	212	212	74
EF7992	8" 24V Puller/S1G200-AH77-52	2.3	55	642	1090	235	235	186	186	74
EF7998	10" 24V Pusher/S1G250-AI37-48	4.4	105	1130	1920	279	279	212	212	74
EF7999	10" 24V Puller/S1G250-AH37-48	4.4	105	1130	1920	279	279	212	212	74

ebm-papst W3G Series

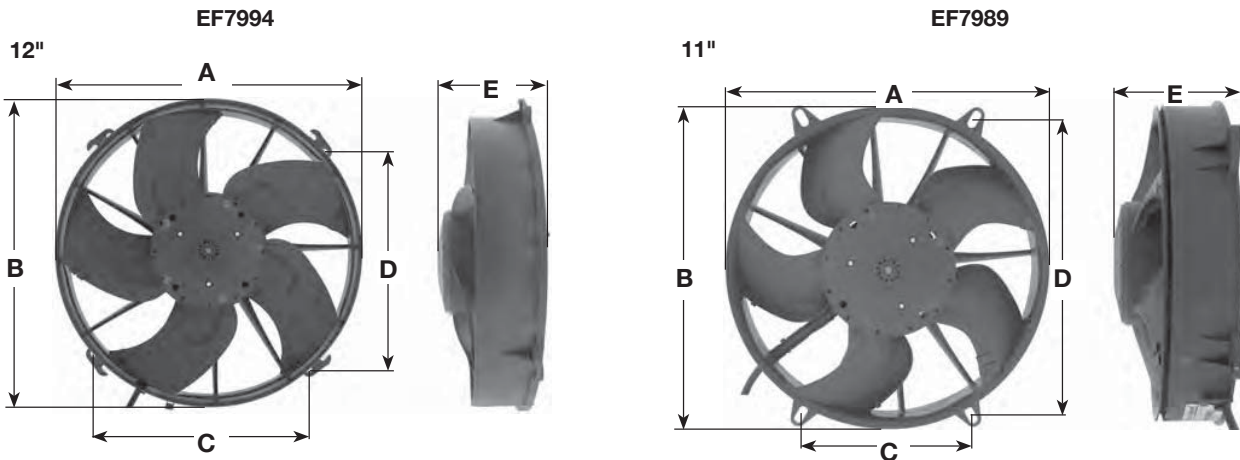

Part No.	Description	Amps	Watts	CFM	m3/h	A	B	C	D	E
EF7989	11" 24V Pusher/W3G280-EQ26-03	7.0	168	1419	2410	303	303	172	298	94
EF7994	12" 24V Puller/W3G300-ER26-05	8.7	209	1636	2780	330	330	237	237	94



ebm-papst A1G Series

EF7991

Motor & Blade Assembly (Plastic Blade)

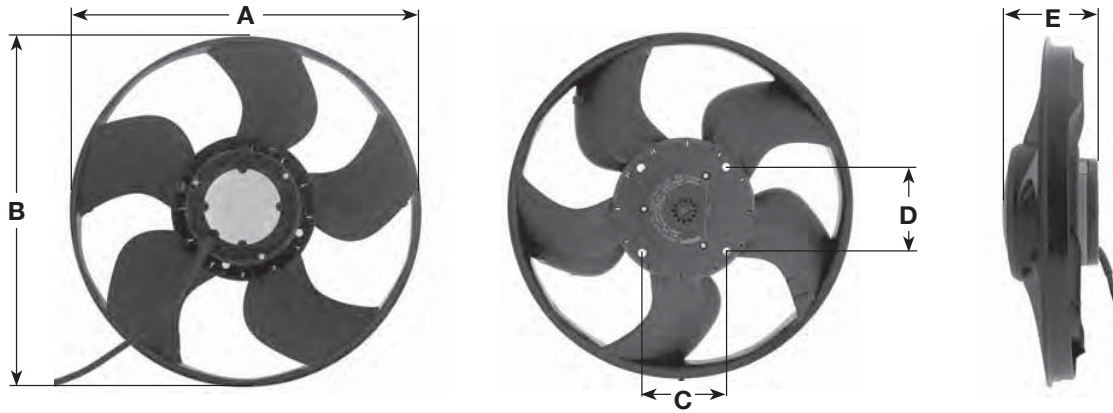

Part No.	Description	Amps	Watts	CFM	m3/h	A	B	C	D	E
EF7991	11" 12V Pusher/A1G280-AA79-11	7.3	90	1065	1810	292	292	42	42	78
EF7981	12" 24V Puller/A1G300-AE19-52 (Steel)	4.0	90	1536	2610	300	300	58	58	79

Electrical Connection

For simplicity, some wires have been omitted

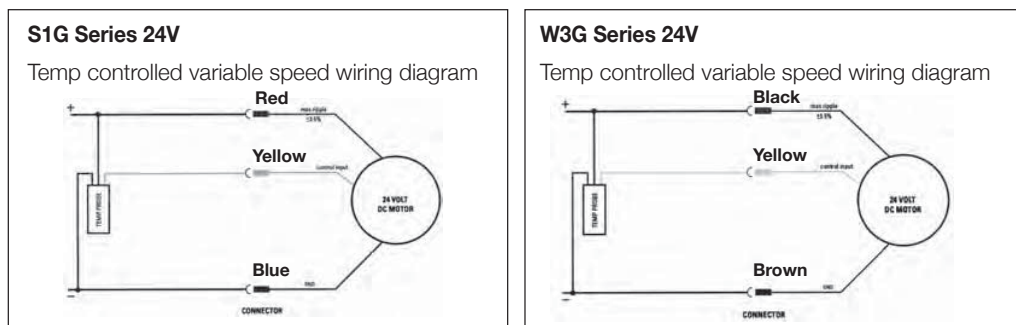

Accessories

EF7987
Fan Grille

Suits W3G Series plastic assemblies

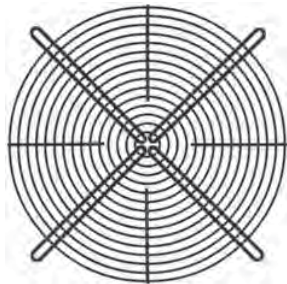

SE4997*

Loom connector lead with adaptor plug

Suits EBM-Papst blower assemblies

*Does not suit EM7993



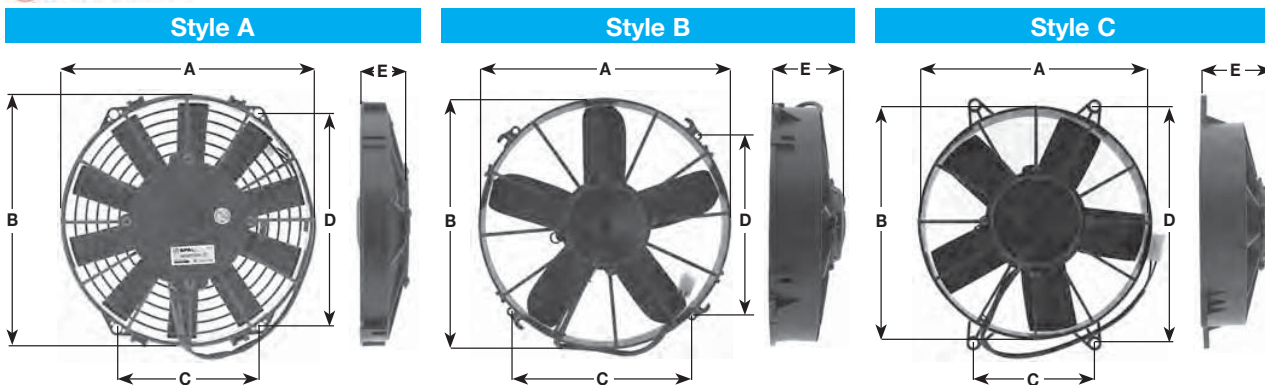

*nominated assemblies Long Life 10,000hrs

Straight 12V	Style	Description	Amps	Watts	CFM	m3/h	A	B	C	D	E
EF3571	A	4" (96mm) 12V Puller	2.2	26	148	250	109	109	82	82	58
EF3570	C	5" (130mm) 12V Puller	4.8	58	342	579	144	144	110	110	58
EF3602	A	6.5" (167mm) 12V Puller	5	60	313	530	178	184	135	135	52
EF3553	A	8" (190mm) 12V Pusher	6.7	80	407	690	202	210	151	151	52
EF3500	A	9" (225mm) 12V Puller	6.7	80	596	1010	246	246	139	206	52
EF3501	A	9" (225mm) 12V Pusher	8.3	100	673	1140	246	246	139	206	52
EF3502	A	10" (255mm) 12V Puller	5.8	70	643	1090	268	284	142	247	52
EF3503	A	10" (255mm) 12V Pusher	5.4	65	631	1070	268	284	142	247	52
EF9631*	C	10" (255mm) 12V Puller	10.5	126	1103	1870	269	278	145	286	95
EF3504	A	11" (280mm) 12V Puller	6.2	74	755	1280	294	310	155	269	52
EF3604*	C	11" (280mm) 12V Puller	12.8	154	1375	2330	304	315	173	299	95
EF3505	A	11" (280mm) 12V Pusher	7.6	91	985	1670	294	310	155	268	62
EF3506	A	12" (305mm) 12V Puller	13.5	162	1328	2250	319	335	168	291	88
EF3606*	B	12" (305mm) 12V Puller	13.5	162	1316	2230	331	331	238	238	95
EF3524	A	12" (305mm) 12V Pusher	8.2	98	1009	1710	319	336	168	291	62
EF3507	A	13" (330mm) 12V Puller	7.5	90	962	1630	345	361	181	313	52
EF3508	A	13" (330mm) 12V Pusher	7.1	85	991	1680	345	361	181	313	52
EF3547	A	14" (350mm) 12V Puller	9.5	114	1310	2220	367	382	191	331	62
EF3647*	A	14" (350mm) 12V Puller	17.3	208	1623	2750	367	382	191	331	88
EF3548	A	14" (350mm) 12V Pusher	8.7	104	1263	2140	367	382	191	331	62
EF3509	A	16" (385mm) 12V Puller	10.7	128	1469	2490	397	412	207	358	62
EF3609*	A	16" (385mm) 12V Puller	17.3	208	1788	3030	397	412	207	358	88
EF3510	A	16" (385mm) 12V Pusher	10.5	126	1505	2550	397	412	207	358	62
Straight 24V	Style	Description	Amps	Watts	CFM	m3/h	A	B	C	D	E
EF3648	A	8" (190mm) 24V Puller	2.4	58	384	650	202	209	151	151	52
EF9629*	A	8" (190mm) 24V Pusher - Thermal protection	2.4	58	384	630	202	209	151	151	52
EF3511	A	9" (225mm) 24V Puller	4	96	690	1170	247	247	139	206	52
EF3512	A	9" (225mm) 24V Pusher	4.1	98	696	1180	247	247	139	206	52
EF3513	A	10" (255mm) 24V Puller	5	120	791	1340	269	284	142	247	52
EF3514	A	10" (255mm) 24V Pusher	4.5	108	779	1320	269	284	142	247	52
EF3614*	C	10" (255mm) 24V Pusher	5.3	127	1097	1860	269	303	145	286	95
EF3615*	C	10" (255mm) 24V Puller	5.7	137	1174	1990	269	303	145	286	95
EF3515	A	11" (280mm) 24V Puller	4.4	106	997	1690	294	310	155	268	62

Spal Universal Straight Blade Fans



Straight 24V	Style	Description	Amps	Watts	CFM	m3/h	A	B	C	D	E
EF3516	A	11" (280mm) 24V Pusher	4.5	108	861	1460	294	310	155	268	52
EF3517	A	12" (305mm) 24V Puller	5.4	130	1162	1970	319	335	168	291	62
EF3546*	B	12" (305mm) 24V Puller	7.4	178	1711	2900	331	330	238	238	95
EF3525	A	12" (305mm) 24V Pusher	4.6	110	1062	1800	319	335	168	291	62
EF3625*	B	12" (305mm) 24V Pusher	7.1	170	1628	2760	331	331	238	238	95
EF3646*	B	12" (305mm) 24V Puller	7.6	182	1422	2410	331	331	238	238	95
EF3649*	A	12" (305mm) 24V Pusher	8.8	211	1469	2490	331	331	238	238	95
EF3518	A	13" (330mm) 24V Puller	4.4	106	1204	2040	345	361	181	313	62
EF3519	A	13" (330mm) 24V Pusher	4.3	103	1180	2000	345	361	181	313	62
EF3549	A	14" (350mm) 24V Puller	4.9	118	1280	2170	366	382	191	331	62
EF3550	A	14" (350mm) 24V Pusher	4.5	108	1239	2100	366	382	191	331	62
EF3520	A	16" (385mm) 24V Puller	5.5	132	1463	2480	397	412	206	357	62
EF3610*	A	16" (385mm) 24V Pusher	8.7	209	2089	3540	397	412	206	357	88

Spal Universal Skew Blade Fans

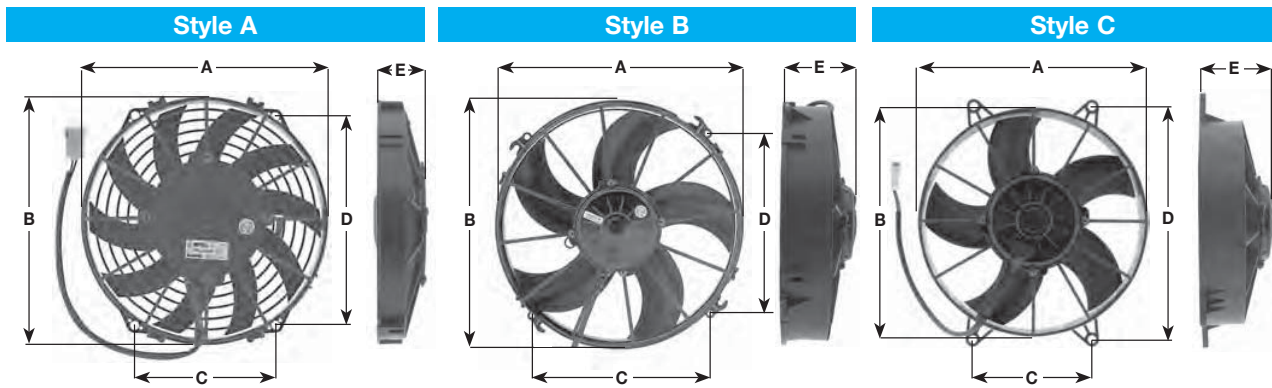

*nominated assemblies Long Life 10,000hrs

Skew 12V	Style	Description	Amps	Watts	CFM	m3/h	A	B	C	D	E
EF3526	A	9" (225mm) 12V Puller	5.7	68	602	1020	246	246	139	206	52
EF3527	A	9" (225mm) 12V Pusher	5.8	70	590	1000	246	246	139	206	52
EF3528	A	10" (255mm) 12V Puller	5.6	67	708	1200	268	284	142	246	52
EF3529	A	10" (255mm) 12V Pusher	5.6	67	708	1200	268	284	142	246	52
EF3629*	C	10" (255mm) 12V Pusher	9.6	115	1033	1750	269	278	145	286	95
EF3530	A	11" (280mm) 12V Puller	6.4	77	779	1320	294	310	155	269	52
EF3531	A	11" (280mm) 12V Pusher	6.4	77	832	1410	294	310	155	269	52
EF3635*	B	11" (280mm) 12V Puller	12.3	148	1298	2200	315	315	173	299	95
EF3532	A	12" (305mm) 12V Puller	13.5	162	1328	2250	319	335	168	291	62
EF3533	A	12" (305mm) 12V Pusher	12.6	151	1292	2190	319	335	168	291	62
EF3572*	A	12" (305mm) 12V Puller	13.5	162	1328	2250	319	335	168	291	62
EF3632*	B	12" (305mm) 12V Puller	13.9	167	1640	2780	331	331	238	238	95
EF3633*	B	12" (305mm) 12V Pusher	13.9	167	1687	2860	331	331	238	238	95
EF3657*	A	14" (350mm) 12V Puller	17.3	208	1623	2750	366	382	192	332	88
EF3534*	A	16" (385mm) 12V Puller	19.5	234	2024	3430	397	412	206	357	88
EF3634	A	16" (385mm) 12V Puller - HP	26	312	3000	5097	400	414	207	358	93
EF3535*	A	16" (385mm) 12V Pusher	21.5	258	1959	3320	400	414	207	358	88



Spal Universal Skew Blade Fans

Skew 24V	Style	Description	Amps	Watts	CFM	m3/h	A	B	C	D	E
EF3536	A	9" (225mm) 24V Puller	4	96	690	1170	246	246	139	206	52
EF3636*	B	9" (225mm) 24V Puller	4.5	108	785	1330	238	248	139	206	96
EF3537	A	9" (225mm) 24V Pusher	3.9	94	696	1180	246	246	139	206	52
EF3538	A	10" (255mm) 24V Puller	3.9	94	767	1300	268	284	142	246	52
EF3539	A	10" (255mm) 24V Pusher	3.7	89	826	1400	268	284	142	246	52
EF3540	A	11" (280mm) 24V Puller	3.8	91	856	1450	294	310	155	268	52
EF3541	A	11" (280mm) 24V Pusher	3.6	86	879	1490	294	310	155	268	52
EF3637*	C	11" (280mm) 24V Puller	7	168	1499	2540	303	315	173	299	95
EF9630*	C	11" (280mm) 24V Pusher	7.4	178	1146	2450	315	315	173	299	95
EF3542	A	12" (305mm) 24V Puller	3.4	82	991	1680	319	335	168	291	52
EF3543	A	12" (305mm) 24V Pusher	3.5	84	956	1620	319	335	168	291	52
EF3642*	B	12" (305mm) 24V Puller	7.1	170	1564	2650	331	331	238	238	95
EF3643*	B	12" (305mm) 24V Pusher	8.5	204	1682	2850	331	331	238	238	95
EF3650*	A	14" (350mm) 24V Puller	8.9	214	1841	3120	366	382	192	332	88
EF3544*	A	16" (385mm) 24V Puller	7	168	1776	3018	400	414	207	358	88
EF3545*	A	16" (385mm) 24V Pusher	11	264	2036	3459	400	414	207	358	88

Spal Universal Dual Fans



Dual Fan Measuring Legend

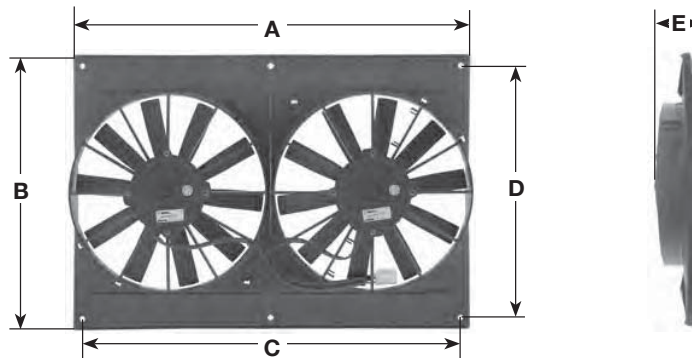

Part No.	Description	Amps	Watts	CFM	m3/h	A	B	C	D	E
EF4028	2 x 11" (280mm) 12V Puller	13.6	165	1689	2870	596	413	566	377	82.5
EF3580	2 x 11" (280mm) 12V Puller	29.8	360	2713	4610	596	413	566	377	108

EF3690
Temperature Switch Kit
 85 Degrees on, 74 Degrees off.
 Includes relay & harness.



EF3691
Temperature Switch
 85 Degrees on, 74 Degrees off.
 3/8" NPT Stainless Thread.



EF3692
Temperature Switch Kit
 90 Degrees on, 80 Degrees off.
 Includes relay & harness.



EF3693
Temperature Switch
 90 Degrees on, 80 Degrees off.
 3/8" NPT Stainless Thread.



EF3694
Relay Harness
 Suits EF3691 & EF3693



SE0027
Wire Loom Extension
 High Performance Fan
 Suits EF3634



EF3552
Fan Gasket
 Suits VA18 Type Fans



EF3521
Mounting Feet
 Raised Profile (4mm)



EF3551
Mounting Feet
 Flush



EF3522
Mounting Feet
 45 Degrees Left,
 Raised Profile (4mm)



EF3523
Mounting Feet
 45 Degrees Right,
 Raised Profile (4mm)



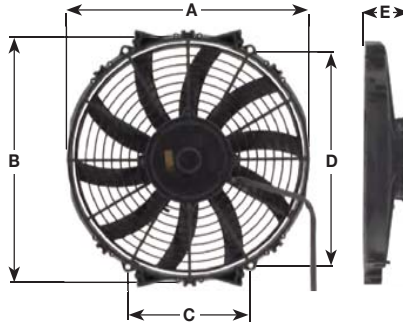

Skew 12V	Description	Amps	Watts	CFM	m3/h	A	B	C	D	E
EF8901	6.5" (165mm) 12V Puller / Reversible	6.5	130	375	636	179	179	135	135	62
EF8902	8" (190mm) 12V Puller / Reversible	8.1	130	540	915	202	210	151	151	63
EF8904	9" (225mm) 12V Puller / Reversible	7.7	130	790	1339	247	247	139	139	63
EF8906	10" (255mm) 12V Puller / Reversible	7.9	130	950	1610	269	285	142	247	63
EF8908	11" (280mm) 12V Puller / Reversible	7.4	130	1110	1881	294	310	155	269	63
EF8910	12" (305mm) 12V Puller / Reversible	7.7	130	1155	1958	318	336	168	291	81
EF8912	12" (305mm) 12V Puller / Reversible	18	225	1595	2653	318	336	168	291	81
EF8914	14" (350mm) 12V Puller / Reversible	10.1	160	1555	2636	367	382	191	331	73
EF8916	14" (350mm) 12V Puller / Reversible	17.2	225	2135	3619	367	382	191	331	81
EF8918	16" (385mm) 12V Puller / Reversible	12.3	160	1810	3068	400	414	207	359	73
EF8920	16" (385mm) 12V Puller / Reversible	18	225	2170	3678	400	414	207	359	81
Skew 24V	Description	Amps	Watts	CFM	m3/h	A	B	C	D	E
EF8903	8" (190mm) 24V Puller / Reversible	4.1	130	484	820	202	210	151	151	63
EF8905	9" (225mm) 24V Puller / Reversible	3.3	130	679	1151	247	247	139	139	63
EF8907	10" (255mm) 24V Puller / Reversible	4	130	937	1588	269	285	142	247	63
EF8909	11" (280mm) 24V Puller / Reversible	4.5	130	1075	1822	294	310	155	269	63
EF8911	12" (305mm) 24V Puller / Reversible	5	130	1180	2000	318	336	168	291	81
EF8913	12" (305mm) 24V Puller / Reversible	6.7	225	1433	2429	318	336	168	291	81
EF8917	14" (350mm) 24V Puller / Reversible	8.2	225	1902	3224	367	382	191	331	81
EF8921	16" (385mm) 24V Puller / Reversible	9.9	225	2052	3478	400	414	207	359	81

EF8922*
Mounting Feet
 90 Degree
 Champion Series

EF8928*
Fan Mount Rubber Spacer
 Champion Series

EF8990*
Pigtail Harness
 Champion Series

EF8927**
Nylon Tie Mount Kit
 Heavy Duty
 130 Watt Champion Series

 Picture unavailable at time of printing
 refer www.cooldrive.com.au



 Picture unavailable at time of printing
 refer www.cooldrive.com.au

 Picture unavailable at time of printing
 refer www.cooldrive.com.au

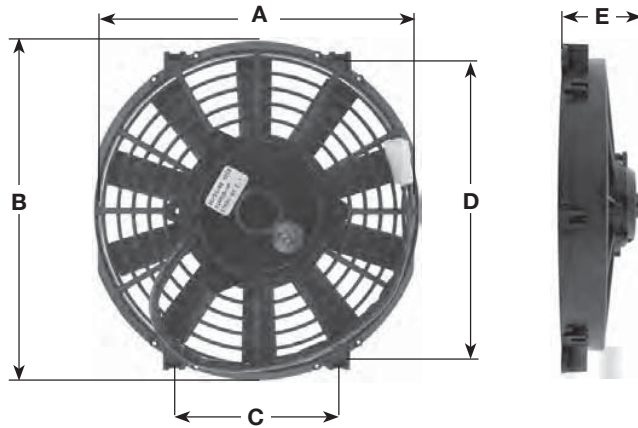

 Picture unavailable at time of printing
 refer www.cooldrive.com.au

* Included with all Maradyne Champion Series Fans ** Included with Maradyne Champion Series 130 watt fans only

Baco Fan Measuring Legend

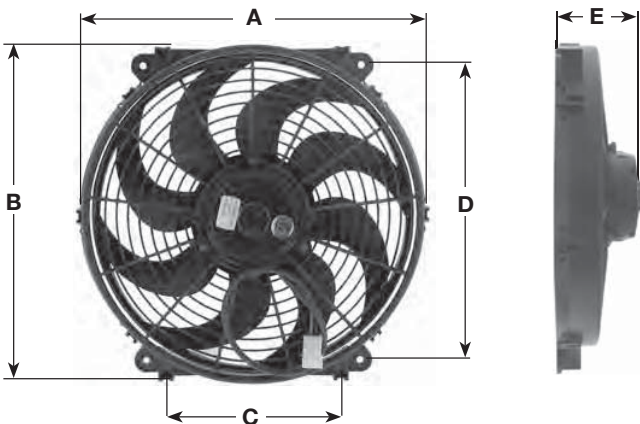

Straight 12V	Description	Amps	Watts	CFM	m3/h	A	B	C	D	E
EF9131	8" 12V Pusher / Reversible	7.5	90	340	578	205	204	107	186	82
EF9100	9" 12V Pusher / Reversible	11.7	140	570	968	243	262	123	232	86
EF9101	10" 12V Pusher / Reversible	11.7	140	650	1104	272	286	131	250	86
EF9103	11" 12V Pusher / Reversible	11.7	140	780	1325	295	312	150	277	88
EF9104	12" 12V Pusher / Reversible	14.6	175	980	1665	320	335	180	285	89
EF9105	14" 12V Pusher / Reversible	19.2	230	1150	1954	357	374	180	328	100
EF9106	16" 12V Pusher / Reversible	19.2	230	1650	2803	408	425	206	372	100
Straight 24V	Description	Amps	Watts	CFM	m3/h	A	B	C	D	E
EF9107	9" 24V Pusher / Reversible	5.8	140	570	968	243	262	123	232	86
EF9108	10" 24V Pusher / Reversible	5.8	140	650	1104	272	286	131	250	86
EF9109	11" 24V Pusher / Reversible	5.8	140	780	1325	295	312	150	277	88
EF9111	12" 24V Pusher / Reversible	7.3	175	980	1665	320	335	180	285	89
EF9112	14" 24V Pusher / Reversible	9.6	230	1150	1954	357	374	180	328	100
EF9113	16" 24V Pusher / Reversible	9.6	230	1650	2803	408	425	206	372	100



The skew blade design represents the latest in innovative design providing a new standard in efficient, low profile and low noise fans.

Features:

- Fully reversible blades for bi-directional air flow
- Mineral/nylon fan & shroud construction
- Multiple mounting points
- Full finger guard protection
- High efficiency
- Low profile

Note: Mounting feet are not included in the fan part numbers listed on this page. (See accessories for suitable mounting feet).

Skew 12V	Description	Amps	Watts	CFM	m3/h	A	B	C	D	E
EF4019	10" 12V Pusher / Reversible	7.5	90	650	1104	290	276	130	249	64
EF4021	11" 12V Pusher / Reversible	7.5	90	870	1478	315	310	132	272	64
EF4023	13" 12V Pusher / Reversible	11.7	140	1430	2430	368	352	185	315	101
EF4025	16" 12V Pusher / Reversible	12.5	150	1650	2803	425	400	208	368	104
EF4026	16" 12V Pusher / Reversible	19.2	230	1900	3228	425	400	208	368	113
Skew 24V	Description	Amps	Watts	CFM	m3/h	A	B	C	D	E
EF4020	10" 24V Pusher / Reversible	3.8	90	650	1104	290	276	130	249	64
EF4022	11" 24V Pusher / Reversible	3.8	90	870	1478	315	310	132	272	64
EF4024	13" 24V Pusher / Reversible	5.8	140	1430	2430	368	352	185	315	101

Tripac Style - Skew Blade Fans

Tripac Fan Measuring Legend

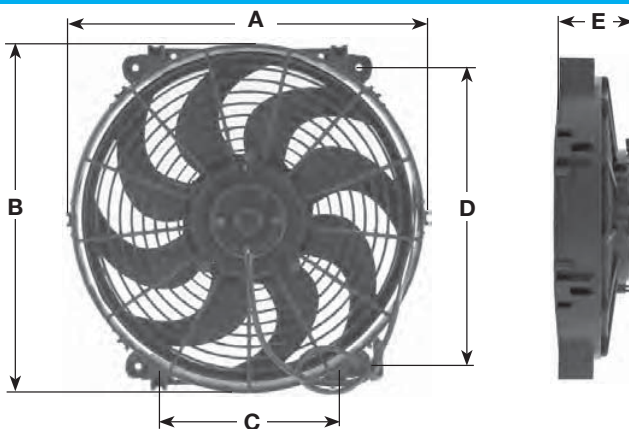

Skew 12V	Description	Amps	Watts	CFM	m3/h	A	B	C	D	E
EF4027	9" 12V Pusher / Reversible	7.5	90	570	970	244	242	126	230	62
EF4040	10" 12V Pusher / Reversible	7.5	90	600	1019	282	270	132	245	65
EF4038	11" 12V Pusher / Reversible	7.5	90	875	1487	317	292	149	280	65
EF4036	13" 12V Pusher / Reversible	10.8	130	1250	2124	368	351	185	310	86
EF4033	16" 12V Pusher / Reversible	18.8	225	2320	3942	426	400	207	350	105
Skew 24V	Description	Amps	Watts	CFM	m3/h	A	B	C	D	E
EF4018	9" 24V Pusher / Reversible	3.8	90	570	970	244	242	126	230	62
EF4039	10" 24V Pusher / Reversible	3.8	90	650	1104	282	270	132	245	65
EF4037	11" 24V Pusher / Reversible	3.8	90	880	1495	317	292	149	280	65
EF4035	13" 24V Pusher / Reversible	5.4	130	1188	2018	368	351	185	310	86
EF4032	16" 24V Pusher / Reversible	9.4	225	2320	3942	426	400	207	350	105

Cooltemp Universal - Straight Blade Fans



Straight 12V	Description	Watts	Application
EFFA02	10" 12V Fan Reversible Blades	80W	Condenser Mount (Pusher)
EF0023	12" 12V Fan Reversible Blades	85W	Condenser Mount (Pusher)
EFFA70	14" 12V Fan Reversible Blades	120W	Radiator Mount (Puller)
Straight 24V	Description	Watts	Application
EFFA06	10" 24V Fan Reversible Blades	80W	Condenser Mount (Pusher)
EF0028	12" 24V Fan Reversible Blades	85W	Condenser Mount (Pusher)
EFFA71	14" 24V Fan Reversible Blades	120W	Radiator Mount (Puller)

Complete Kit 12V	Complete Kit 24V	Description	Motor (W)	Set Up	W (mm)	D (mm)	H (mm)	Part No. (Fan Only) 12V	Part No. (Fan Only) 24V
EF0035	EF0036	DCSL8 - Reversible	90	Push	208	225	52	EF0135	EF0136
		DCSL9 - Reversible	90	Push	249	242	64	EF0160	EF0161
EF0045	EF0046	DCSL10 - Reversible	90	Push	270	290	64	EF0145	EF0146
		DCSLX10 - Reversible	84	Push	275	278	50	EF0147	EF0148
		DCSL10 - Sealed Motor						EF0744	EF0745
		DCSL12 - Old Style						EF0762	EF0763
EF0062	EF0063	DCSL12 - Reversible	108	Push	293	293	51	EF0162	EF0163
		DCSL12 - Sealed Motor						EF0746	EF0760
		DCSL14 - Old Style						EF0764	EF0765
EF0064	EF0065	DCSL14 - Reversible	130	Push	350	348	77	EF0164	EF0165
		DCSL14 - Reversible High Performance	156	Push	350	348	94	EF0107	
EF1066	EF0067	DCSL16 - Reversible	225	Push	424	400	100	EF0166	EF0172

Universal Exhaust/Dash Mount Fans

EF4050
Rooftop Ventilator
Exhaust Fan, 190mm, 12V



EF4051
Rooftop Ventilator
Exhaust Fan, 230mm, 12V



EF0103
Dash Mount Fan, 12V
2 Speed



EF0106
Dash Mount Fan, 24V
2 Speed



EM9064
Dash Mount Fan, 24V, Red Dot
2 Speed



Fan Accessories/Thermostats/Blades/Shrouds

EF0314
12" Blade



EF9039
Shroud
Suits DCSL10 fans



EF9020
Thermatic Fan Switch
Mechanical



Blades

Fan Blades Kysor - Red Dot



Part No.	Application	Dia.	Blades	Pitch Width	Rotation	Hub Size	Hub Location	Material
HF5381	Kysor	203	5	27	CCW	7.9	Front	Aluminium
HF5382	Kysor	203	5	27	CW	7.9	Back	Aluminium
HF5530	Kysor	178	5	38	CW	7.9	Front	Aluminium
HF5605	Kysor	205	5	50	CW	7.9	Front	Aluminium
HF5330	Kysor	228	4	65	CW	7.9	Front	Aluminium
HF6001	Kysor	254	4	54	CW	7.9	Front	Aluminium
HF8080	Red Dot - suits R9725	203	5		CW	7.9		Aluminium
HF8100	Red Dot - suits R9720, R9727, R6060, R6000	254	4		CW	7.9		Aluminium
HF8110	Red Dot - suits R6160	254	4		CW	7.9		Aluminium

Fan Blades

Part No.	Application	Diameter
EF8205	Universal	10" with steel centre
HF9003	Universal	17" Plastic

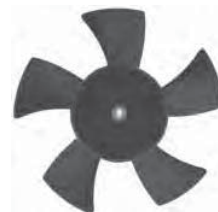

Accessories

EF7924
Mounting Feet
Straight - Each



EF7925
Mounting Feet
Baco Fans - Pkt. 4



EF7926
Mounting Feet
Baco Fans - Each



EF7946
Mounting Feet
Tripac Fans - Each
23mm thick



EF7923
Fan Mount Kit
Universal - Pkt. 4



EF7927
Tie Rod Mount Kit
Universal - Pkt. 4



EF7930
Fan Thermostat



Universal Single Shaft Fan Motors

Style A Vented Motors

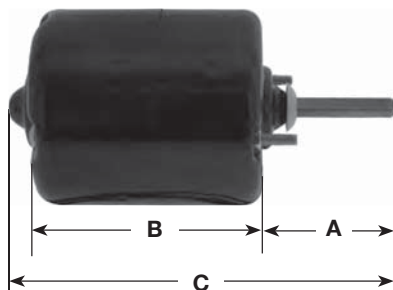

Style B Sealed Motors

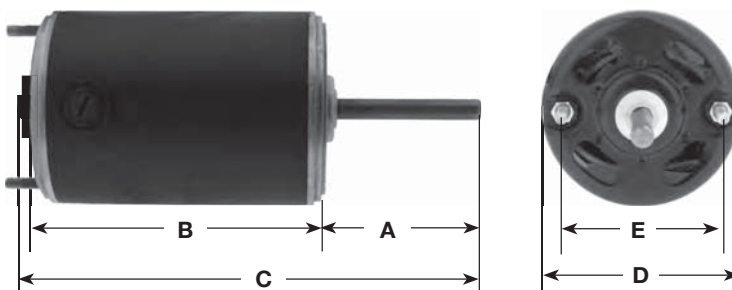

UNIVERSAL FAN MOTORS

Jaylec Single Shaft

Part No.	Volts	Speed	A	B	C	D	E	Shaft Dia.	Style	Rotation
EM9019	12	1	58	98	161	75	61	7.9	B Sealed	CW
EM9022	12	1	59	108	182	75	58	7.9	B Sealed	CW
EM9066	12	3	50	85	148	75	58	7.9	A Vented	CW
EM9067	12	3	50	85	148	75	58	7.9	A Vented	CCW
EM9020	24	1	58	98	161	75	61	7.9	B Sealed	CW
EM9024	24	1	59	108	174	75	58	7.9	B Sealed	CW
EM9068	24	3	52	86	149	75	58	7.9	A Vented	CW
EM9069	24	3	50	85	148	75	58	7.9	A Vented	CCW

Kysor Single Shaft



Part No.	Application	Volts	Speed	A	B	C	D	E	Shaft Dia.	Style	Rotation	Genuine Cross Ref.
EM5165	Kysor HD1000, KA300	12	1	25	106	150	78	N/A	7.9	Sealed	CCW	275165 / 1075009
EM1812	Kysor Condenser	24	1	28	104	132	76	N/A	7.9	Sealed	CW	275230 / 1075012
EM5265	Kysor HD1000 Kombo Condenser	24	1	28	104	N/A	76	N/A	7.9	Sealed	CW	275265 / 1075016

Red Dot Single Shaft



Part No.	Application	Volts	Speed	A	B	C	D	E	Shaft Dia.	Style	Rotation	Genuine Cross Ref.
EM2102		12	1	27	105	147	79	Plate (Flange)	7.9	Vented	CW	73R2102 / RD-5-4937-0P
EM4802	R-6000, R-9720, R-9730	12	1	28	101	152	76	58.7	7.9	Sealed	CW	73R0512 / RD-5-5120-0P
EM7174	R-6100, R-9725, R-9727	12	1	31	101	155	76	58.7	7.9	Sealed	CW	73R0542 / RD-5-7129-0P
EM7017	R-4170, R-4180, R-5040, R-7830	12	1	41	101	168	76	58.7	7.9	Vented	CCW	73R0402 / RD-5-6526-1P
EM7006	R-4013, R-4070, R-7810	12	2	38	86	146	76	58.7	7.9	Vented	CCW	73R0602 / RD-3106-13P / 2807-517-012

Universal Single Shaft Fan Motors

Part No.	Application	Volts	Speed	A	B	C	D	E	Shaft Dia.	Style	Rotation	Genuine Cross Ref.
EM0204	R3911-H, R-7211-5	24	1	36	76	134	76	58.7	7.9	Sealed	CCW	73R0204 / RD-3106-24
EM0504	Suits EV9204	24	1	25	101	149	76	58.7	7.9	Sealed	CW	73R0204 / RD-3106-24P
EM0364	Caterpillar	24	1	25	101	152	76	58.7	7.9	Sealed	CCW	73R0364 / RD5-6071-0 Cat # 174-1505
EM4812	R-6000, R-9720, R-9730	24	1	28	101	152	76	58.7	7.9	Sealed	CW	73R0514 / RD-5-5120-24P
EM7175	R-6160, R-9725, R-9727	24	1	31	101	155	76	58.7	7.9	Sealed	CW	73R0544 / RD-5-7129-24P
EM0454	R-5040	24	1	41	98	160	76	58.7	7.9	Vented	CCW	73R0454 / RD-5-3751-24P
EM7117	R-6130, R-7830	24	1	41	101	161	76	58.7	7.9	Vented	CCW	73R0404 / RD-5-4827-24P
EM7106	R-4013, R-7810	24	2	38	86	146	76	58.7	7.9	Vented	CCW	73R0604 / RD-3106-13-24P

Universal Double Shaft Fan Motors

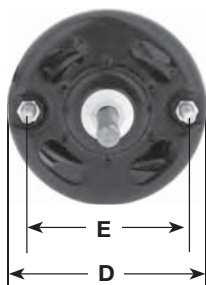

Double Shaft

Part No.	Application	Volts	Speed	A	B	C	D	E	Shaft Dia.	Style	Rotation
EM0922	Formula King	12	1	59/61	73	230	67	58	7.9	Sealed	CW
EM9018	Universal	12	1	93/101	90	292	75	58	7.9	Sealed	CW
EM9032	Universal	12	3	85/86	105	297	76	58.7	7.9	vented	CW
EM9075	Suits AMC UHD-1	12	3	72/75	85	254	76	58.7	7.9	Vented	CW
EM7052	Universal	12	3	109/121	106	348	90	72	9.5	Vented	CW/CCW
EM9017	Universal	24	1	93/101	90	292	75	58	7.9	Sealed	CW
EM9033	Suits EM0195	24	3	85/86	105	297	76	58.7	7.9	Vented	CW
EM9081	Suits AMC UHD-1	24	3	72/75	86	254	76	58.7	7.9	Vented	CW
EM0926	Formula King	24		60/60	80	230	75	68	7.9	Sealed	CW

Universal Double Shaft Fan Motors



Kysor Double Shaft												
Part No.	Application	Volts	Speed	A	B	C	D	E	Shaft Dia.	Style	Rotation	Genuine Cross Ref.
EM7018	Kysor KA-300 blwr 83> on	12	1	63.5	120	247	76	N/A	7.9	Vented	CCW	275152 / 1099004
EM5256	Kysor HD1000 Kombo	24	1	67	N/A	N/A	77	N/A	7.9	Sealed	CCW	275256 / 1075014

Red Dot Double Shaft Motors

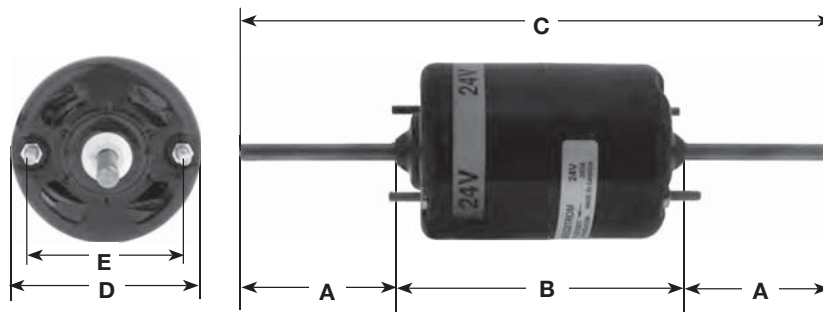

Red Dot Double Shaft												
Part No.	Application	Volts	Speed	A	B	C	D	E	Shaft Dia.	Style	Rotation	Genuine Cross Ref.
EM7022	R-8515, R-8535, R-9727	12	1	51	112	214	76	58.7	7.9	Sealed	CW/ CCW	73R4202 / RD-5-3757-12P / E2809-541-028
EM4262	R-6000, R-6100, R-8545	12	1	54	122	230	76	58.7	7.9	Vented	CW/ CCW	73R4262 / RD-5-5121-1P
EM7073	R-9750, R-9775	12	1	92	122	306	76	58.7	7.9	Vented	CW/ CCW	73R4252 / RD-5-5121-0P
EM7003	R-2000, R-8500, R-9755	12	3	76	101	253	76	58.7	7.9	Vented	CW/ CCW	73R4102 / RD-5-3780-0P / 2807-513-087
EM7122	R-8515, R-8535, R-9727	24	1	51	112	214	76	58.7	7.9	Sealed	CW/ CCW	73R4204 / RD-5-3757-24P / E2809-541-027
EM4264	R-6000, R-6100, R-8545	24	1	54	122	230	76	58.7	7.9	Vented	CW/ CCW	73R4264 / RD-5-5121-2P
EM7019	R-5045, R-7250, R-9757, R-9800	24	1	73	135	281	76	58.7	7.9	Vented	CW/ CCW	73R4424 / RD-5-5049-2P
EM4064	R-2100, R-2110	24	1	82	93	257	76	58.7	7.9	Vented	CW/ CCW	73R4064 / RD-5-6969-0P
EM7173	R-2120, R-9750	24	1	92	122	306	76	58.7	7.9	Vented	CW/ CCW	73R4254 / RD-5-5121-24P



Jayair Universal Fan Motors

Part No.	Volts, Watts	Shaft
EM1156	12V, 130W	25mm
EM1116	24V, 130W	25mm
EM1115	24V, 130W	25mm
EM1113	H/Duty 24V, 130W	25mm



Cooltemp Universal Fan Motors

Part No.	Volts, Watts	Reference
EM0001	12V, 80W	FM0001
EM0002	24V (FM0003)	FM0003



Davies Craig Universal Fan Motors

Part No.	Volts, Watts	Reference
EM9303	12V, 80W	SSW-9511E
EM9301	12V, 80W	SSW-9511E & SPACER
EM9304	24V, 80W	SSW-9524E
EM9302	24V, 80W	SSW-9524E & SPACER
EM9312	24V, 80W Sealed Type	SSW-9584E
EM9315	12V, 130W	Y-706-21
EM1160	24V, 130W	Y-706-23
EM1118	12V, 225W	ZD 1788A



Audi

EF1430

Audi 80, 8/78-3/87

Radiator Fan Motor & Blade

191959455T

**EF1218**

Audi 80, 8/84-8/86

Radiator Fan Motor & Blade

165959455L / N

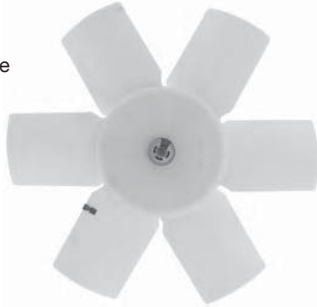
**EF1308**

Audi 80, 86-95

Audi 90, 87>

Audi 100, 82-90

Radiator Fan Motor & Blade

811959455R

**EF1217**

Audi 80, 86-95

Audi 90, 87>

Audi 100, 71-76

Radiator Fan Motor & Blade

165959455AA / T

**EF1216**

Audi A3, 9/98>

Audi TT, 9/98>

Radiator Fan Motor & Blade

345mm diameter
6X0959455A / F**EF1312**

Audi A4, 7/02-3/09

Audi S4, 04-09

Radiator Fan

8E0959455J

**EF1310**

Audi A4, 95-00

Condenser Fan

All engines

**EF1432**

Audi A6, 3.0, 3.2Lt, 09-11

Dual Assembly

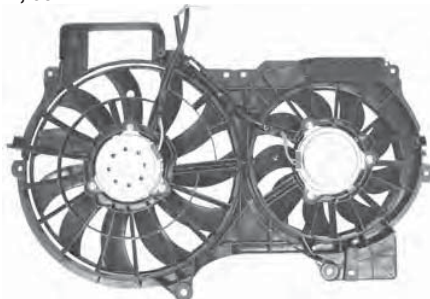
**EF1219**

Audi Q7, 3/06-5/11

Radiator Fan Motor & Blade

7L0959455B / E



EF1425
Audi Q7, 3/06>

Radiator Fan Motor & Blade

Includes Module
7L0959455F
95595913400



EF1426
Audi Q7, 3/06>

Radiator Fan Motor & Blade

Includes Module
7L0959455G

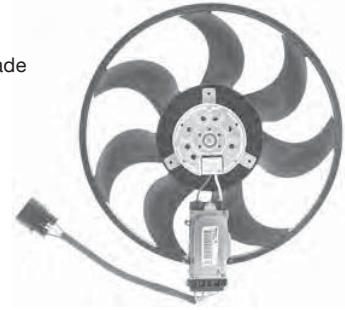

EF6511
BMW 3 Series, E30, 318i, 323i, 82-87

Condenser Fan



Picture unavailable at time of printing
refer www.cooldrive.com.au

EF6514
BMW 3 Series, E36, 4 cyl, 95-02

Condenser Fan

Bosch systems



Picture unavailable at time of printing
refer www.cooldrive.com.au

EF6501
BMW 3 Series, E36, 93-99

Condenser Fan

64508364093
64541385160

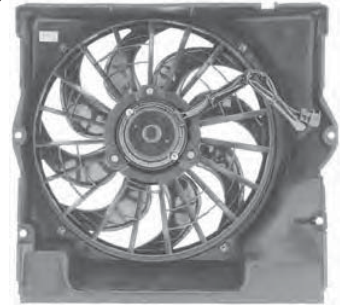

EF6550
BMW 3 Series, E36, 93-95
BMW 3 Series, E46, 98-05

Radiator Fan

Includes Module
64546988913

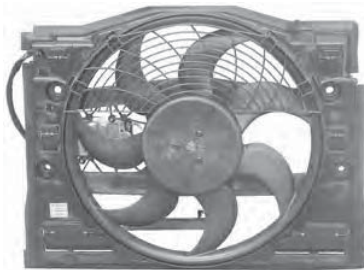

EF6515
BMW 3 Series, E46, 98-5/05

Condenser Fan

Includes Module



Picture unavailable at time of printing
refer www.cooldrive.com.au

EF1155
BMW 3 Series, E46, 318i, 98-03

Radiator Fan Motor &
Blade

No Electric
Control Module
17117525508

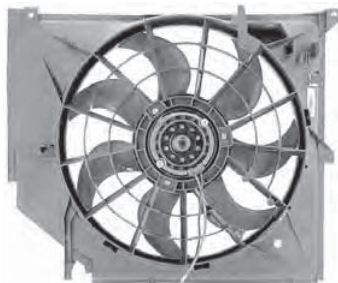

EF6555
BMW 3 Series, E46, 318i, 98-03

Radiator Fan

Includes Module
17117525508

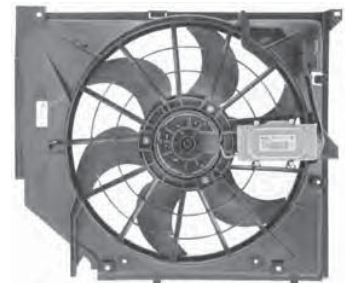

EF1088
BMW 5 Series, E39, 96-9/98

Condenser Fan

6454380780

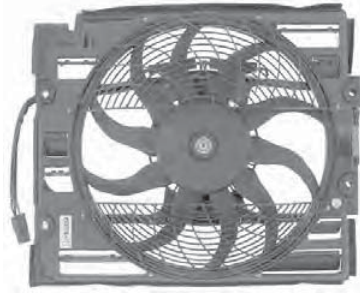

EF6503
BMW 5 Series, E34, 88-96
BMW 7 Series, E32, 88-96

Condenser Fan

includes Resistor
64541392913



EF6513
BMW X5, 3.0, 4.4Lt Petrol, 00-04

Condenser Fan



Picture unavailable at time of printing
refer www.cooldrive.com.au

EF6512
BMW X5, 3.0Lt Diesel, 00-04

Condenser Fan



Picture unavailable at time of printing
refer www.cooldrive.com.au



EF1337
Chrysler Crossfire, 03>

Radiator Fan



EF1159
Chrysler PT Cruiser, 01-02

Condenser Fan



EF1383
Chrysler Voyager, 4 & 6 cyl, 01-02

Condenser Fan

Right Hand Mount



Picture unavailable at time of printing
refer www.cooldrive.com.au

EF1384
Chrysler Voyager, 4 & 6 cyl, 01-02

Radiator Fan

Left Hand Mount



Picture unavailable at time of printing
refer www.cooldrive.com.au

EF1158
Chrysler Voyager, V6, 96-99

Dual Assembly

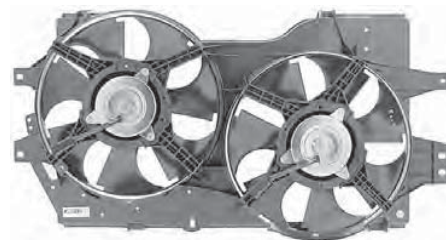

Citroen/Daewoo

EF1367
Citroen Berlingo, 11/02>

Radiator Fan

3 Speed



Picture unavailable at time of printing
refer www.cooldrive.com.au

EF1366
Citroen C5, 00-05

Radiator Fan



Picture unavailable at time of printing
refer www.cooldrive.com.au

EF1122
Daewoo Cielo, 1.5Lt, >97
Daewoo Espero, 1.5Lt, >97

Condenser Fan

96164864



EF5146
Daewoo Kalos, 05>

Radiator Fan

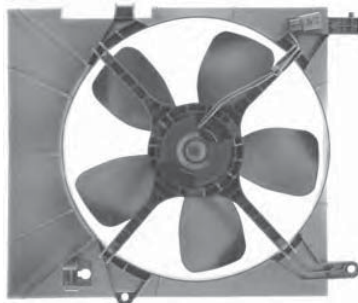

EF1179
Daewoo Lanos, 97>

Radiator Fan



EF1120
Daewoo Lanos, 97>

Condenser Fan

96182264

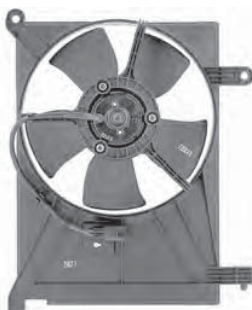

EF1178
Daewoo Leganza, 2.0Lt, 97-01
Daewoo Nubira Series I & II,
2.0Lt, 97-01

Condenser Fan



Daihatsu/Doosan

EF3912
Daihatsu Charade, 02>

Radiator Fan

16360-B2010

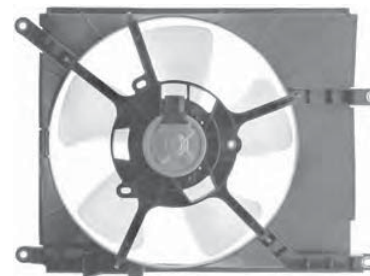

EF3911
Daihatsu Sirion, 97>

Radiator Fan

16670-97201

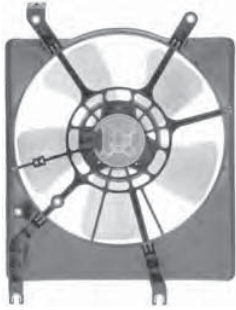

EF3930
Daihatsu Sirion, 1.0Lt

Condenser Fan

88590-97402



EF3910
Daihatsu Sirion, 1.3Lt

Condenser Fan

88590-97401



EF1011
Doosan Solar V Excavator

Condenser Fan

300506-00004



Ford

EF5375
Ford Escape, 3.0Lt, V6, 01>

Dual Assembly

MZAJ0615025

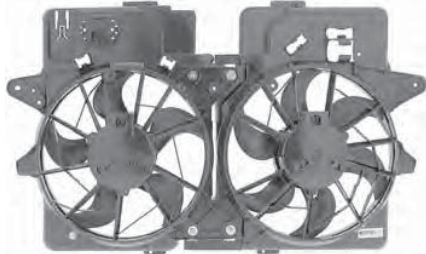

EF8004
Ford Falcon BF, FG, 05>

Radiator Fan

3R238C607BC



EF8005
Ford Falcon BF, FG, 05>

Radiator Fan

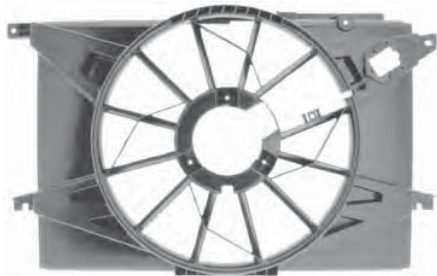

EM5512
Ford Falcon BA II, BF, 5/05>

Radiator Fan Motor



EF8003
Ford Falcon BA, 6 & 8 cyl, 02-04

Dual Assembly

BA8C607A

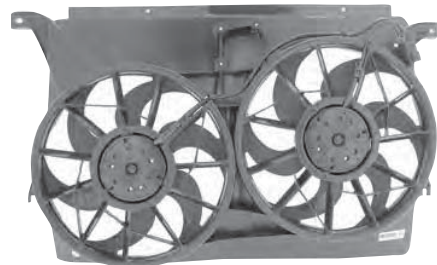

EF8002
Ford Falcon AU, 99-02

Dual Assembly

ER8C607A

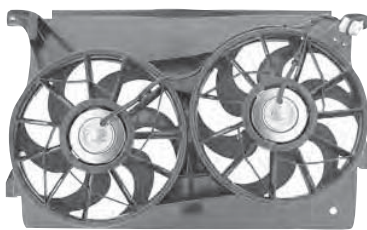

EF5528
Ford Falcon AU, BA, 99-04

Radiator Fan Blade

340mm diameter



EM5510
Ford Falcon AU, BA, 99-04

Radiator Fan Motor

Driver side
ER8K621



EM5511
Ford Falcon AU, BA, 99-04

Radiator Fan Motor

Passenger side



EF3034
Ford Falcon EL, 6 cyl 95-97
Ford Falcon XH Ute,
6 cyl, 95-97

Dual Assembly

Single plug
EL8C607A



EM5503
Ford Falcon EL, 95-97

Radiator Fan Motor

Passenger side
EL8K621A



EM5504
Ford Falcon EL, 95-97

Radiator Fan Motor

Driver side
EL8K621B



EF5515
Ford Falcon EF, EL, 94-97

Radiator Fan Blade



EF3031
Ford Falcon EF, 94-95

Dual Assembly

2 x plugs
EF8C607A

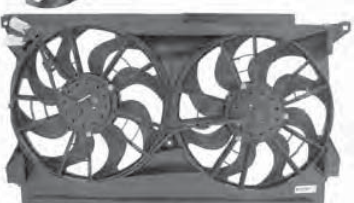

EM5500
Ford Falcon EF, 94-95

Radiator Fan Motor

2 speed
EF8K621B



HF9009
 Ford Falcon EA-ED, 3/88-8/94
 Ford Falcon XG Ute, MPI, 3/93-3/96

Radiator Fan Blade

EA8600A



EF1121
 Ford Festiva WF, 4/98 >

Condenser Fan

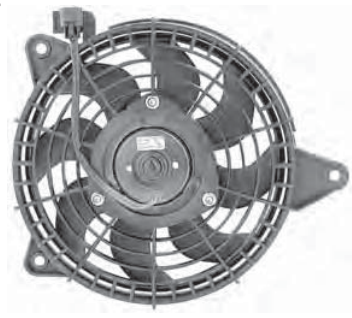

EF1150
 Ford Festiva WB, 94-98

Radiator Fan



EF1100
 Ford Festiva, 1.3Lt, 88-93

Radiator Fan



EF1400
 Ford Festiva, 88-93

Condenser Fan



EF5385
 Ford Focus, 2.0Lt, 5/05>

Radiator Fan

Includes Module Z602150225B

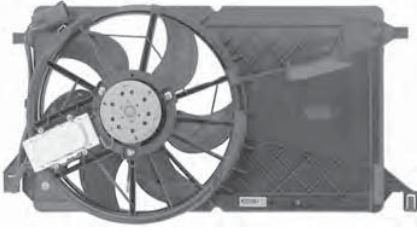

EF1231
 Ford Focus, 1.8, 2.0Lt, 9/02-4/05

Dual Assembly



EF5379
 Ford Laser KJ, KN, KQ, 1/98>

Condenser Fan



EF5372
 Ford Laser KN, 1.8Lt, 97>

Radiator Fan Blade



EF5373
 Ford Laser KN, 1.8Lt, 97>

Condenser Fan Shroud

ZL0415210B



EF5020
Ford Laser KJ Liata, 95-98

Condenser Fan



EF1151
Ford Laser KJ Liata, 1.8Lt, 95-98

Radiator Fan



EF5371
Ford Laser KJ, 1.8Lt, 94-99

Radiator Fan Blade

E35815140

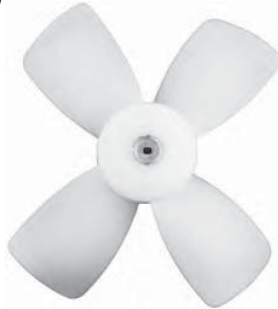

EF1089
Ford Laser KF, KH, 90-95

Radiator Fan

Carburettor engines



EF1135
Ford Laser KF, KH, 1.6Lt, 90-94

Condenser Fan



EF1232
Ford Mondeo HE, 2/00-12/00

Radiator Fan



EF1165
Ford Mondeo, HA, HB, HC, HD
7/95-2/00

Dual Assembly



EF1097
Ford Telstar AR, 83-86

Radiator Fan



EF8003
Ford Territory, SX, SY 4.0Lt 6 cyl
5/04-4/11

Dual Assembly

BA8C607A

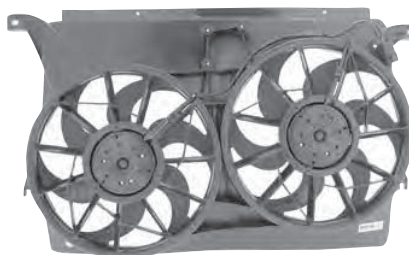

EF1163
Ford Transit, 2.3Lt Petrol
12/00-10/06

Radiator Fan



EF1164
 Ford Transit, 2.3Lt Petrol
 12/00-10/06

Condenser Fan

EF1233
 Ford Transit, 2.4Lt Diesel, 01>

Radiator Fan

1C158C607FD



EM2030
 Hino

Condenser Fan Motor

24V

EM5460
 Hino

Radiator Fan Motor

24V
 S871041080A

EF3722
 Hino Dutro, 06>

Condenser Fan

88590-37070

Picture unavailable at time of printing refer www.cooldrive.com.au

EF3730
 Hino Dutro, 06>

Condenser Fan Blade

EM3700
 Hino Dutro, 06>

Radiator Fan Motor

24V

EM5592
 Hino FC, 97>

Condenser Fan Motor

24V

EM1290
 Hino Ranger, 06>

Condenser Fan Motor

24V

EM1220
Hino Ranger, 00>

Condenser Fan Motor

24V
88450-1070



EF0670
Hino SS Ranger 50 series, 00>

Condenser Fan Blade



Holden

EF1251
Holden Astra AH, 12/04>

Radiator Fan Motor & Blade

From VIN 55084254
Manual Transmission
13205947



EF1253
Holden Astra AH, 12/04>

Radiator Fan Motor & Blade

From VIN 55084254
Auto Transmission
13207167



EF1257
Holden Astra AH, 12/04>

Condenser Fan Shroud

From VIN 55084254
Auto Transmission
13126384

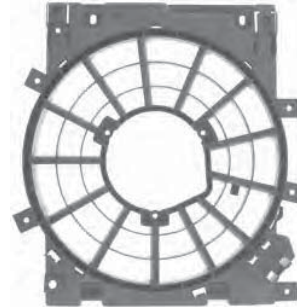

EF1255
Holden Astra AH, 12/04>

Condenser Fan Motor & Blade

From VIN 55084254
Auto Transmission
13126382



EF1256
Holden Astra AH, 11/04-12/04

Radiator Fan Shroud

To VIN 55084253
Auto & Man Transmission
13128831

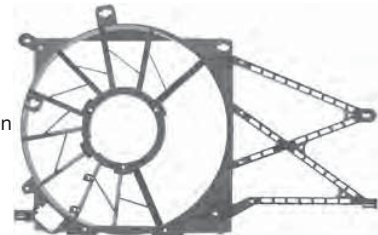

EF1250
Holden Astra AH, 11/04-12/04

Radiator Fan Motor & Blade

To VIN 55084253
Manual Transmission
13126354



EF1252
Holden Astra AH, 11/04-12/04

Radiator Fan Motor & Blade

Includes Resistor
To VIN 55084253
Auto Transmission
13147274

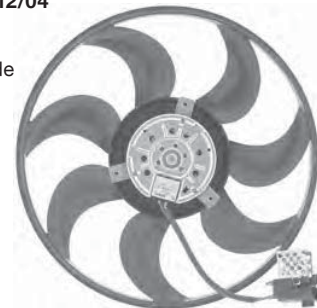

EF1254

Holden Astra AH, 11/04-12/04

Condenser Fan Motor & Blade

Includes Resistor
To VIN 55084253
Auto Transmission
13147278**EF1244**

Holden Astra TS, 2.2Lt, 00-09

Radiator Fan Motor & Blade

Includes Resistor
90576739
24431825**EF1243**Holden Astra TS, 2.2Lt, 9/00-1/09
Holden Astra Convertible Turbo,
00-05

Radiator Fan Motor & Blade

Includes Resistor
90570740
24431828**EF1242**

Holden Astra TS, 2.2Lt, 9/00-1/09

Condenser Fan Motor & Blade

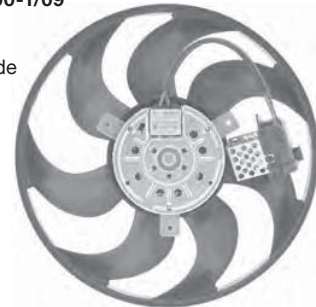
Includes Resistor
9132916
24431829**EF1246**

Holden Astra TS, 98-05

Radiator Fan Motor & Blade

Includes Resistor
13128687**EF2754**

Holden Astra TS, 9/98>11/01

Condenser Fan Shroud

90570741

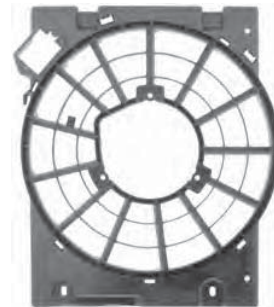
**EF2753**

Holden Astra TS, 9/98-11/01

Condenser Fan Motor & Blade

Includes Resistor
24431827**EF1249**

Holden Astra TS, 10/98>

Radiator Fan

90572751

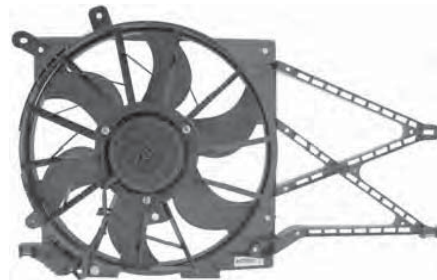
**EF1130**

Holden Astra TS, 10/98>

Condenser Fan

90572756

**EF1245**

Holden Astra TR, 9/96-9/98

Radiator Fan

90504897
90511262

EF1241
Holden Astra, >9/98

Radiator Fan Motor & Blade

90347536



EF5146
Holden Barina TK, 1.6Lt, 12/05>

Radiator Fan

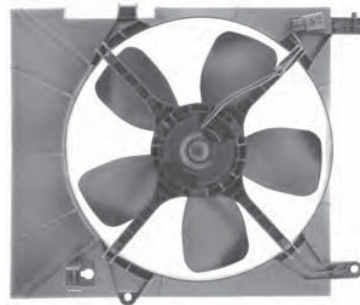

EF1213
Holden Barina TK, 1.6Lt, 12/05>

Radiator Fan Shroud

93742533



EF1193
Holden Barina XC, 9/01-12/05

Condenser Fan

From VIN 4400001
Suits CN6326



EF1180
Holden Barina XC, 9/01-12/05

Radiator Fan

with A/C

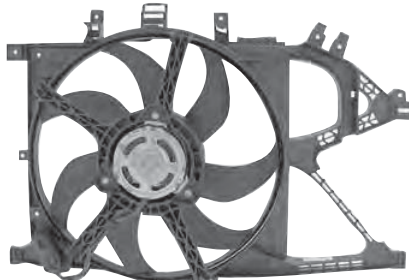

EF1181
Holden Barina XC, 1.4, 1.8Lt
9/01-12/05

Condenser Fan

Suits CN6322



EF5144
Holden Barina SB, 5/94-2/01

Radiator Fan

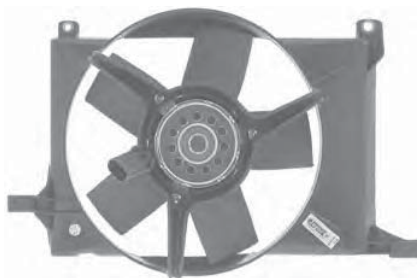

EF5147
Holden Barina SB, 5/94-2/01

Radiator Fan



EF1247
Holden Barina SB, 5/94-2/01
Holden Combo, 3/96-9/02

Radiator Fan Motor & Blade

Air International system
9117716

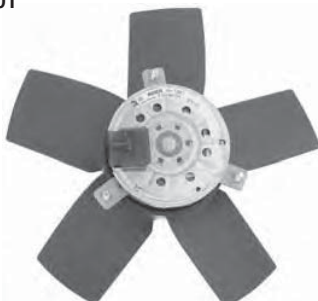

EF5150
Holden Barina SB, 5/94-2/01
Holden Combo, 3/96-9/02

Condenser Fan

Air International system
Suits CN7033



EF1194
Holden Barina, 4/94-2/01

Condenser Fan

Suits CN6318



EF1241
Holden Calibra, 6/90-7/97

Radiator Fan Motor & Blade

90347536



EF5590
Holden Captiva, Diesel, 3/07>

Dual Assembly

96829535



EF5591
Holden Captiva, Petrol, 10/06>

Dual Assembly

96629064

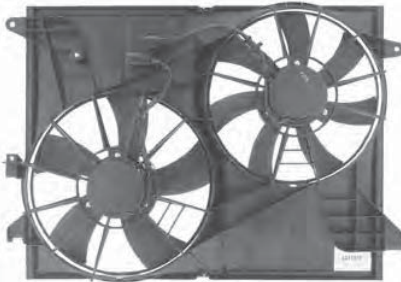

EF2533
Holden Commodore VE, V6, 8/06>

Dual Assembly

92191936

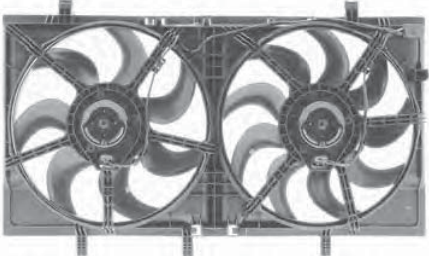

EF2534
Holden Commodore VE, V8, 8/06>

Dual Assembly

92191937

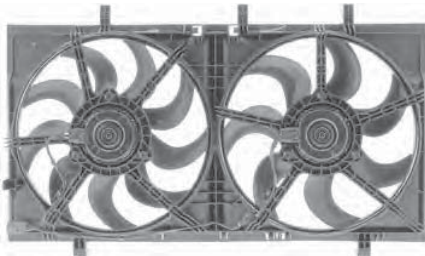

EF3747
Holden Commodore VZ, V8, 04-06

Dual Assembly

Auto Transmission

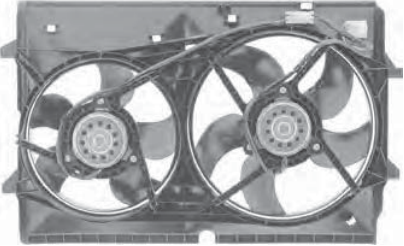

EF3749
Holden Commodore VZ, V8, 04-06

Dual Assembly

Manual Transmission

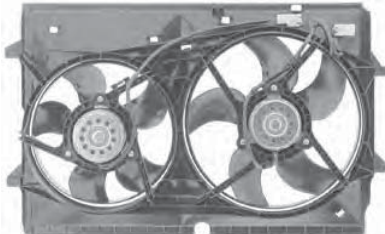

EF3745
Holden Commodore VZ, V6, 04-06

Dual Assembly

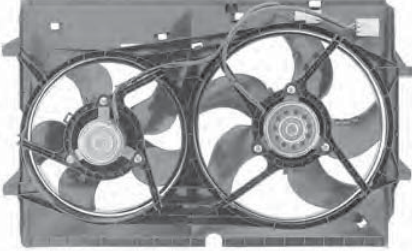

EF1198
Holden Commodore VZ, 6 & 8 cyl, 04-06
Holden Crewman VZ, 6 & 8 cyl, 04-06
Holden Adventra VZ, 6 & 8 cyl, 04-06

Radiator Fan Shroud

92147981

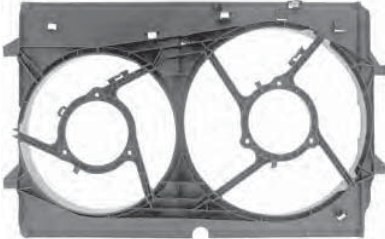

EF2748

Holden Commodore VZ, V8, 04-06
Holden Crewman VZ, V6, 04-06
Holden Adventra VZ, V6, 04-06

Radiator Fan Motor & Blade

Driver side, Large
92147983

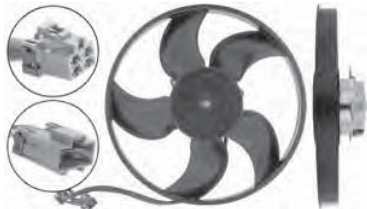

EF2747

Holden Commodore VZ, V8, 04-06
Holden Crewman VZ, V6, 04-06
Holden Adventra VZ, V6, 04-06

Radiator Fan Motor & Blade

Passenger side, Small
92147982



EF2750

Holden Crewman VZ, V8, 04-06
Holden Adventra VZ, V8, 04-06

Radiator Fan Motor & Blade

Passenger side, Small
92148990

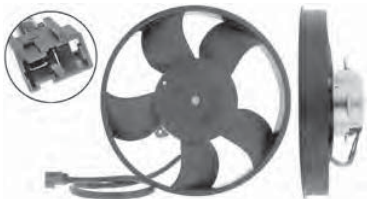

EF2749

Holden Crewman VZ, V8, 04-06
Holden Adventra VZ, V8, 04-06

Radiator Fan Motor & Blade

Driver side, Large
92148991



EF2745

Holden Commodore VZ, V6, 04-06

Radiator Fan Motor & Blade

Driver side, Large
92147985



EF2746

Holden Commodore VZ, V6, 04-06

Radiator Fan Motor & Blade

Passenger side, Small
92147984



EF3743

Holden Commodore VY, V8, 02-04

Dual Assembly

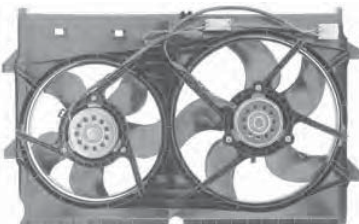

EF3753

Holden Crewman VY, V8, 02-04
Holden Adventra VY, V8, 02-04

Dual Assembly

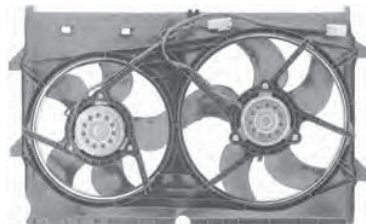

EF3751

Holden Crewman VY, V6, 02-04
Holden Adventra VY, V6, 02-04

Dual Assembly



EF3741

Holden Commodore VY, V6, 02-04

Dual Assembly

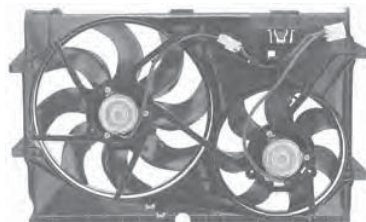

EF1197
Holden Commodore VY, V8, 02-04

Radiator Fan Shroud

92145776

EF1196
Holden Commodore VY, V6, 02-04

Radiator Fan Shroud

92145770

EF2743
Holden Commodore VY, V8, 02-04
Holden Statesman WH, V8 5/00-4/03

Radiator Fan Motor & Blade

Passenger side, Small

92145777

EF2744
Holden Commodore VY, V8, 02-04
Holden Statesman WH, V8 5/00-4/03

Radiator Fan Motor & Blade

Driver side, Large

92145778

EF2741
Holden Commodore VY, V6, 97>

Radiator Fan Motor & Blade

Driver side, Small

92145771

EF2742
Holden Commodore VY, V6, 02-04

Radiator Fan Motor & Blade

Passenger side, Large

92145772

EF1195
Holden Commodore VT, V6, 97-00
Holden Commodore VX, V6, 00-02

Dual Assembly

From VIN L435512

EF1186
Holden Commodore VT, V6, 97-00

Dual Assembly

To VIN L435512
2 x 4 pin plugs

EF4180
Holden Commodore VT, 97-00
Holden Commodore VT, VX, V8, 97-02

Radiator Fan Shroud

To VIN L435512
92140431

EF5850
Holden Commodore VT, VX, 97-02

Radiator Fan Shroud

From VIN L435513
92142559

EF1710
Holden Commodore VT, VX, 97-02

Radiator Fan Blade

305mm diameter
92142563



EM6520
Holden Commodore VT, VX, VU
5.7Lt, V8 98>

Radiator Fan Motor

From VIN L435512



EM6430
Holden Commodore VT, V6, 97>

Radiator Fan Motor

To VIN L435512
92140430



EM1150
Holden Commodore VT, V6, 97-02
Holden Commodore VT, VX, VU, V6,
97-02

Radiator Fan Motor

88mm diameter
92142566



EM5280
Holden Commodore VT, V6, 97-02
Holden Commodore VT, VX, VU, V6,
97-02

Radiator Fan Motor

72mm diameter
92142560



EF2740
Holden Commodore VT, V6, 97-02
Holden Commodore VT, VX, VU, V8,
97-02

Radiator Fan Blade

305mm diameter
92140429



EF1280
Holden Commodore VT, V6, 97-02
Holden Commodore VT, VX,
VU, V6, 97-02

Radiator Fan Blade

340mm diameter
92142562

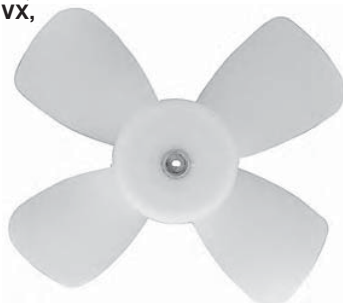

EF1990
Holden Commodore VT, V6, V8, 97-02
Holden Commodore VT, VX, VU, V8,
97-02

Radiator Fan Blade

To VIN L435512
340mm diameter
92140428



EF1185
Holden Commodore VS, V6, 4/95-8/97

Radiator Fan

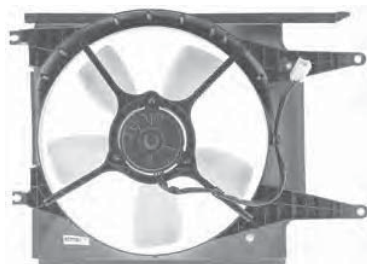

EF2530
Holden Commodore VS, V6, 4/95-8/97

Radiator Fan Shroud

92049284

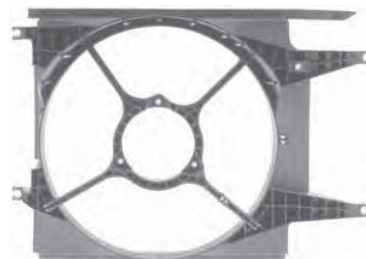

EM6331
Holden Commodore VS, V6, 4/95-8/97

Radiator Fan Motor

92049283

EF2660
Holden Commodore VS, V6, 4/95-8/97

Radiator Fan Blade

92049282

EF1114
Holden Commodore VR, VS, 6 & 8 cyl
7/93-3/97
Holden Commodore VP V8, >3/93

Condenser Fan

EF1184
Holden Commodore VN, VP, VR, 8/88-4/95

Radiator Fan

EF2529
Holden Commodore VN, VP, VR, 8/88-4/95

Radiator Fan Shroud

92035532

EM6332
Holden Commodore VN, VP, VR, 8/88-4/95

Radiator Fan Motor

92035531

EF2659
Holden Commodore VN, VP, VR, 8/88-4/95

Radiator Fan Blade

92035530

HF9005M
Holden Commodore VL, 6 cyl, 84-86

Radiator Fan Blade

2106042L00

EF1382
Holden Cruze JG, 2.0Lt Diesel, 6/09>

Radiator Fan Shroud

13267632
13337279

EF1381
Holden Cruze JG, 2.0Lt Diesel, 6/09>

Radiator Fan Motor & Blade

Right Hand Mount
52421097
13267644

EF1380
Holden Cruze JG, 2.0Lt Diesel, 6/09>

Radiator Fan Motor & Blade

Left Hand Mount
52421103
13267643



EF1350
Holden Cruze YG, 6/02-6/06

Condenser Fan

92125272

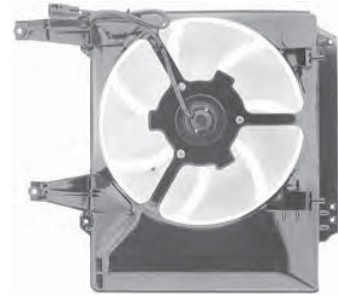

EF1103
Holden Nova LE, LF, 1.6Lt, 8/89-10/94

Radiator Fan

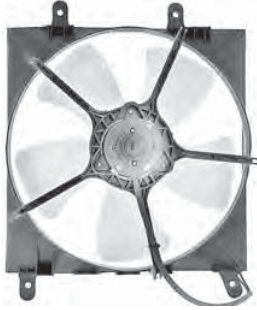

EF1116
Holden Nova LE, LF, 1.6Lt, 8/89-10/94

Condenser Fan



EF1190
Holden Rodeo RA03, 3/03>

Condenser Fan

92148013

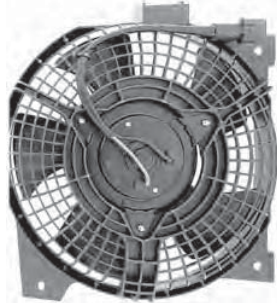

EF1114
Holden Statesman VQ, V8, 11/91-2/94

Condenser Fan



EF1168
Holden Vectra JR, JS, 2.0Lt, 6/97>

Radiator Fan

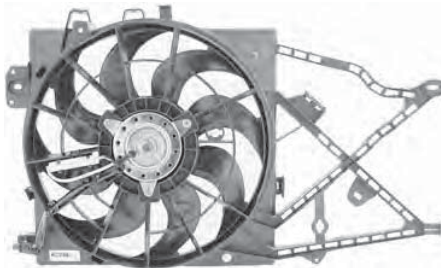

EF1142
Holden Vectra JR, JS, 2.0
2.2, 2.6Lt, 6/97>

Radiator Fan Shroud

vehicles with OE A/C
only

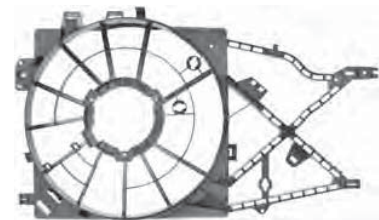

EF1169
Holden Vectra JR, JS, 2.0Lt, 6/97>

Condenser Fan

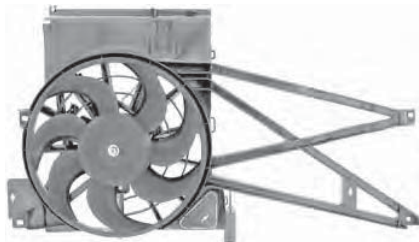

EF1140
Holden Vectra JR, JS, 2.2
2.6Lt, 6/97>

Condenser Fan Motor & Blade

180W
vehicles with OE A/C only



EF1241
Holden Vectra, 9/88-11/95

Radiator Fan Motor & Blade

90347536

EF1244
Holden Zafira TT, 2.2Lt, 6/01-5/06

Radiator Fan Motor & Blade

Includes Resistor
90576739
24431825

EF1242
Holden Zafira TT, 2.2Lt, 6/01-5/06

Condenser Fan Motor & Blade

Includes Resistor
9132916
24431829

EF1249
Holden Zafira TT, 2.2Lt, 6/01-5/06

Radiator Fan

90572751

EF1130
Holden Zafira TT, 2.2Lt, 6/01-5/06

Condenser Fan

90572756



EF1545
Honda Accord, V6, 08>

Radiator Fan

Auto Transmission

EF1546
Honda Accord, V6, 08>

Radiator Fan Shroud

Auto Transmission

EM8671
Honda Accord, V6, 08>

Radiator Fan Motor

Auto Transmission
19030R40A010M1

EF1547
Honda Accord, V6, 08>

Radiator Fan Blade

Auto Transmission
19020RWPJ511M1

EF1535
Honda Accord Euro, 08>

Radiator Fan

Auto Transmission



EF1536
Honda Accord Euro, 08>

Radiator Fan Shroud

Auto Transmission

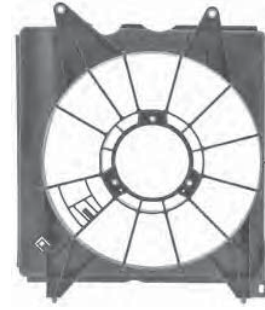

EM8680
Honda Accord Euro, 08>

Radiator Fan Motor

Auto Transmission
38616R40A010M1



EM8650
Honda Accord Euro, 08>

Radiator Fan Motor

Auto Transmission
19030R70A010M1



EF1537
Honda Accord Euro, 08>

Radiator Fan Blade

Auto Transmission
19020RCJA010M1



EF1540
Honda Accord Euro, 08>

Condenser Fan

Auto Transmission
38615R40A01



EF1542
Honda Accord Euro, 08>

Condenser Fan Shroud

Auto Transmission
38615R40A010M1

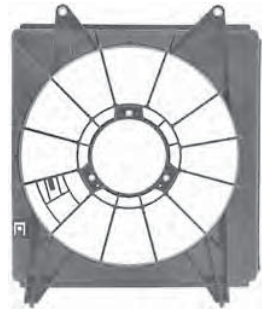

EF1543
Honda Accord Euro, 08>

Condenser Fan Blade

Auto Transmission
38611R40A010M1



EF1262
Honda Accord Euro, 02>

Radiator Fan



EF1147
Honda Accord, V6, 98-02

Radiator Fan



EF5267
Honda Accord, 93-97

Condenser Fan



Picture unavailable at time of printing
refer www.cooldrive.com.au

EF5268
Honda Accord, 93-98

Radiator Fan



Denso systems
Picture unavailable at time of printing
refer www.cooldrive.com.au

EF1102
Honda Accord, 90-94

Radiator Fan



EF1113
Honda Accord, 90-94

Condenser Fan



EF1101
Honda Accord, 86-89

Radiator Fan



EF4810
Honda Civic, 06>

Condenser Fan



EF3120
Honda Civic, 06>

Condenser Fan Shroud

38615RNAA01

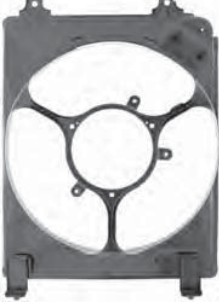

EM3200
Honda Civic, 06>

Condenser Fan Motor

38616RNAA01



EF6350
Honda Civic, 06>

Condenser Fan Blade

38611RNAA01



EF1550
Honda Civic, Hybrid, 04>

Radiator Fan



EF1552
Honda Civic, Hybrid, 04>

Radiator Fan Shroud

19015PZA0030

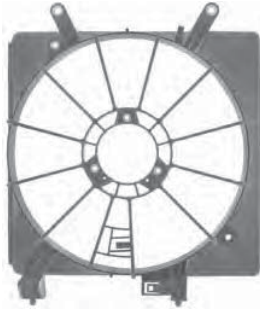

EM5750
Honda Civic, Hybrid, 04>

Radiator Fan Motor



EF1557
Honda Civic, Hybrid, 04>

Radiator Fan Blade

19020PND0030



EF5269
Honda Civic Sedan, 00-06
Honda Civic Hatchback, 00-01

Radiator Fan



Picture unavailable at time of printing
refer www.cooldrive.com.au

EF1146
Honda Civic, 00-02

Condenser Fan



EF1093
Honda Civic, 92-3/96

Condenser Fan



EF1268
Honda CRV, 02-5/05

Radiator Fan

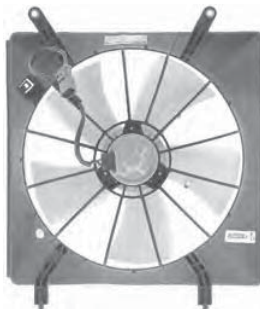

EM2575
Honda CRV, 02>

Radiator Fan Motor

88550-12160



EF1269
Honda CRV, 02-5/05

Condenser Fan



EM2570
Honda CRV, 02>

Condenser Fan Motor



EF1172
Honda CRV, 97-01

Radiator Fan



EF1173
Honda CRV, 97-01

Condenser Fan



EF1263
Honda Integra, 02>

Radiator Fan

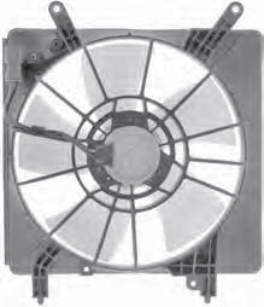

EF1173
Honda Integra, 97-01

Condenser Fan



EF1145
Honda Integra, 97-99

Radiator Fan



EF1267
Honda Integra, 95>

Radiator Fan

19005P3G0031



EF1144
Honda Integra, 94-01

Radiator Fan

Denso systems



EF3182
Honda Jazz, 8/08>

Condenser Fan



EM8930
Honda Jazz, 8/08>



EM3070
Honda Jazz, 8/08>

Condenser Fan Motor

38616PWAJ01



EF1261
Honda Legend, 96-98

Radiator Fan



EF1266
Honda Odyssey, 03>

Condenser Fan



EM5040
Honda Odyssey, 98>

Condenser Fan Motor



EF2170
Honda Odyssey, 98>

Radiator Fan



EF1264
Honda Odyssey

Radiator Fan



EF1261
Honda Prelude, 96-98

Radiator Fan



EM4650
Honda Prelude

Radiator Fan Motor

19030PK1671



EF2165
Honda S2000

Condenser Fan



Hyundai

EF1377
Hyundai Accent, Sedan, 06-08
Hyundai Accent, Hatchback, 06-08

Condenser Fan



Picture unavailable at time of printing
refer www.cooldrive.com.au

EF1370
Hyundai Accent, 6/00>

Radiator Fan

2538025000



EF1373
Hyundai Accent, 6/00>

Radiator Fan Shroud

2535025000



EF1376
Hyundai Accent, 6/00>

Radiator Fan Blade

2523125000



EF1200
Hyundai Accent, 6/00>

Condenser Fan

Auto Transmission
9773025000



EF1374
Hyundai Accent, 6/00>

Condenser Fan Shroud

Auto Transmission
9773525000



EF1201
Hyundai Accent, 6/00>

Condenser Fan

Manual Transmission
9773025100

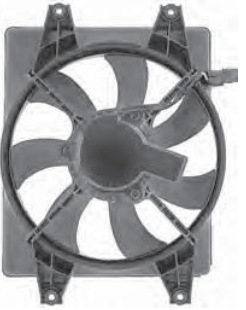

EF1375
Hyundai Accent, 6/00>

Condenser Fan Shroud

Manual Transmission
9773525100



EF1203
Hyundai Accent, 6/00>

Condenser Fan Blade

Auto & Man Transmission
9773725000



EF1285
Hyundai Elantra MD, 6/11-

Radiator Fan

253803X000



Picture unavailable at time of printing
refer www.cooldrive.com.au

EF1277
Hyundai Elantra, 00-02

Radiator Fan



EF1276
Hyundai Elantra, 00-02

Condenser Fan



EF1189
Hyundai Excel, 10/94-99

Radiator Fan

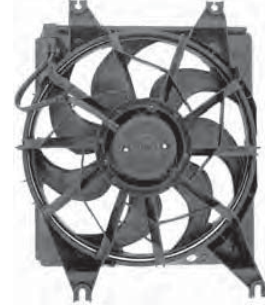

EF1118
Hyundai Excel, 8/94-9/99

Condenser Fan



EF1275
Hyundai Excel X3, 1.5Lt, 8/94-9/99

Radiator Fan

SOHC
2538022020



EM2202
Hyundai Excel X3, 1.5Lt, 8/94-9/99

Radiator Fan Motor

SOHC
2538622020



EF1138
Hyundai Excel X2, 1.5Lt EFI, 6/89-7/94

Condenser Fan

Includes Resistor
9773024001



EF1279
Hyundai Getz, 02>

Condenser Fan



EF1129
Hyundai Grandeur XG30, 7/99>

Condenser Fan

977303800



EF1278
Hyundai i30, Petrol, 10/07>

Radiator Fan

253802H600



EF1368
Hyundai i30, 6/06>

Radiator Fan

Includes Resistor
253802H151

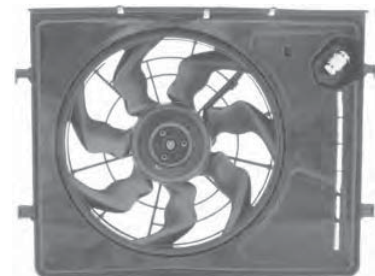

EF1183
Hyundai Lantra J2, 5/95-6/00

Radiator Fan



EF1124
Hyundai Lantra J2, 5/95-5/00

Condenser Fan

9773029060



EF1125
Hyundai Lantra, 5/93-5/95

Condenser Fan

9773029050



EF1202
Hyundai Lavita, 5/01>

Condenser Fan



EF1134
Hyundai S Coupe, 7/92-3/96

Condenser Fan

Includes Resistor
Includes Module



EF1138
Hyundai S Coupe, 3/90-7/92

Condenser Fan

Includes Resistor
9773024001



EF1271
Hyundai Santa Fe, 02-03

Radiator Fan



EF1270
Hyundai Santa Fe, 02-03

Condenser Fan

9773026000



EF1273
Hyundai Sonata, 99-02

Condenser Fan



EF1182
Hyundai Sonata EF, 4 cyl 2.0Lt, 5/98-9/01
Hyundai EF Facelift, 4/01>
Hyundai Trajet, 3/00>

Radiator Fan

2538038000
253803D100



EF1129

Hyundai Sonata EF, 4 cyl 2.0Lt, 5/98-9/01
Hyundai EF Facelift, 4/01>
Hyundai Trajet, 3/00>

Condenser Fan
977303800



EF1132

Hyundai Sonata I & II, 4 cyl 2.0Lt
7/93-4/98

Condenser Fan
9773034001



EF1124

Hyundai RD Coupe, 5/96>

Condenser Fan
9773029060



EF1183

Hyundai RD Coupe, 5/96>

Radiator Fan



EF1207

Hyundai Tucson, 04>

Radiator Fan

Includes Resistor
253802E380
253801S380

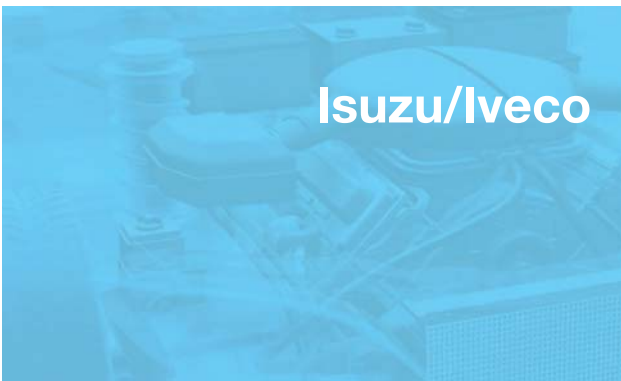
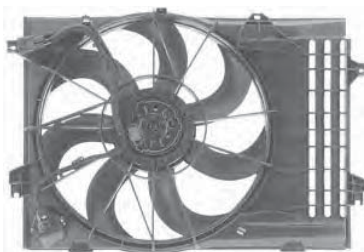

EM1320

Isuzu CXZ, 06>

Radiator Fan Motor



EM8490

Isuzu

Condenser Fan Motor

24V



EF0736

Iveco

Condenser Fan

12V 14"
Heavy Duty Motor

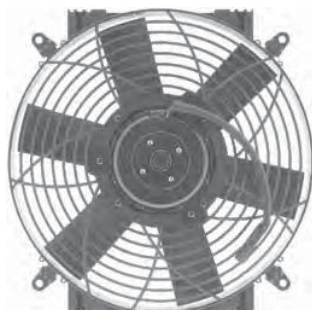

EF1160
Jeep Cherokee, 88-96

Condenser Fan



EF5540
Jeep Grand Cherokee, 09-10

Condenser Fan

55037969AB

Picture unavailable at time of printing refer www.cooldrive.com.au

EF1210
Jeep Grand Cherokee, V6 4.0Lt, 97-01

Condenser Fan

Offset lower mounts



EF1206
Kia Carnival, 9/01>

Condenser Fan

OK53A61482



EF1205
Kia Carnival, 98-4/01

Radiator Fan

OK55215025A



EF1223
Kia Carnival

Condenser Fan

F3004302GQ



EF0039
Kia Mentor Series I, 97-4/98

Condenser Fan



EM0001
Kia Mentor Series I, 97-4/98

Condenser Fan Motor

Cooltemp systems



EF1129
Kia Optima, 9/02>

Condenser Fan

97730-3800



EF1182
Kia Optima, 20/2/01-1/6/01

Radiator Fan



EF1228
Kia Rio, 1.6Lt 4 cyl, 7/05>

Radiator Fan



Picture unavailable at time of printing
refer www.cooldrive.com.au

EF1224
Kia Rio, 1.5Lt 4 cyl, 7/05>

Radiator Fan



EF1087
Kia Rio, 1.5Lt 4 cyl, 1/03-7/05

Condenser Fan



Picture unavailable at time of printing
refer www.cooldrive.com.au

97730-OC100
25380-OC100

EF1220
Kia Rio, 01-03

Condenser Fan

OK30A61710E



EF1222
Kia Shuma, 1/00-4/01
Kia Spectra, 5/01-6/04

Radiator Fan

Auto Transmission

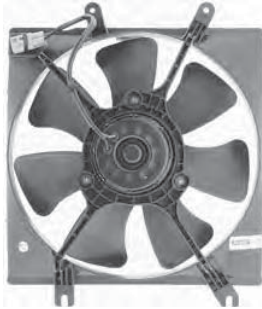

EF1221
Kia Shuma, 1/00-4/01
Kia Spectra, 5/01-6/04

Condenser Fan

Auto Transmission
OK2A161710A



EF0055
Kia Sportage Series I & II, 12/96-10/97

Condenser Fan

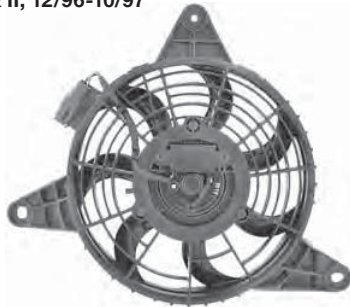

EM2321
Land Rover Discovery, 95-98

Condenser Fan Motor



EF2171
Lexus ES300, 02-03

Dual Assembly

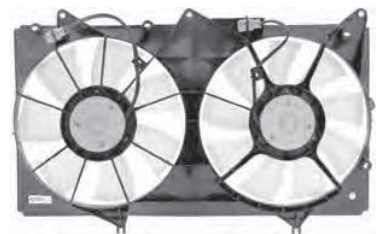

EF2172
Lexus ES300, 99-01

Radiator Fan

Right Hand Mount

**EF2168**
Lexus IS200, GXE10R, 3/99-10/05

Dual Assembly

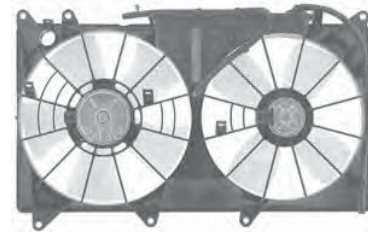
Includes Overflow
Bottle
16360-70010-F**EF2174**
Lexus IS300, 8/01-10/05

Dual Assembly

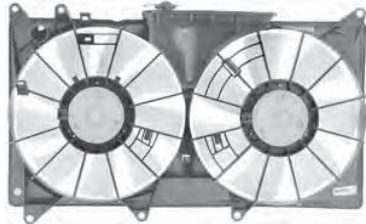
Includes Overflow
Bottle**EF2381**
Lexus IS350, GSE21R, 10/10>

Dual Assembly

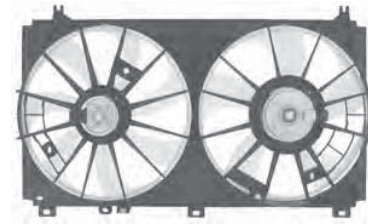
**EF2385**
Lexus IS350, GSE21R, 10/10>

Radiator Fan Shroud

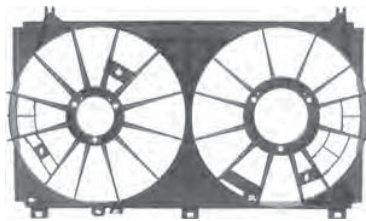
**EF2173**
Lexus RX330, MCU38R, 4/03-1/06

Dual Assembly

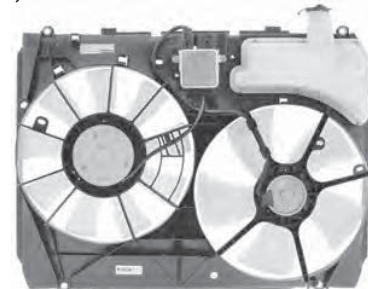
Includes Overflow
Bottle
Includes Module**EF2151**
Lexus RX350, GSU35R, 2/06-1/09

Dual Assembly

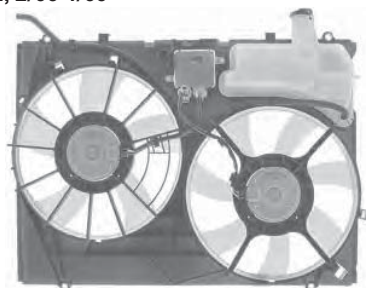
Includes Overflow
Bottle
Includes Module**EF2152**
Lexus RX350, GSU35R, 2/06-1/09

Radiator Fan Shroud

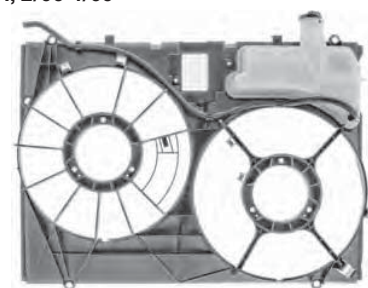
Includes Overflow
Bottle**EM7140**
Lexus RX350, GSU35R, 2/06-1/09

Radiator Fan Motor

16363-20270

**EM8250**
Lexus RX350, GSU35R, 2/06-1/09

Radiator Fan Motor

16363-31160



EF2155

Lexus RX350, GSU35R, 2/06-1/09

Radiator Fan Blade

16361-31210



EF2157

Lexus RX350, GSU35R, 2/06-1/09

Radiator Fan Blade

16361-31220



EF2361

Lexus RX450H, GLY15R, 6/09>

Radiator Fan Shroud

16711-31460

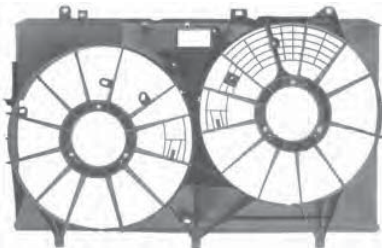

EM4780

Lexus RX450H, GLY15R, 6/09>

Radiator Fan Motor

16363-20390



EM5270

Lexus RX450H, GLY15R, 6/09>

Radiator Fan Motor

16363-31260



EF2363

Lexus RX450H, GLY15R, 6/09>

Radiator Fan Blade

7 Blade
16361-20260



Picture unavailable at time of printing
refer www.cooldrive.com.au

EF2365

Lexus RX450H, GLY15R, 6/09>

Radiator Fan Blade

5 Blade
16361-20250



Picture unavailable at time of printing
refer www.cooldrive.com.au



EM0001

Mazda 121, 1.3Lt, 8/94-96

Condenser Fan Motor

Cooltemp systems



EF1400

Mazda 121, 91-95

Condenser Fan



EF1100
Mazda 121, 88-93

Radiator Fan

Manual Transmission

**EF1282**
Mazda 2, 9/07>

Radiator Fan

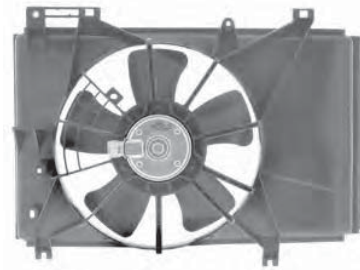
**EF1284**
Mazda 2, 9/07>

Radiator Fan Shroud

ZJ38-15-210

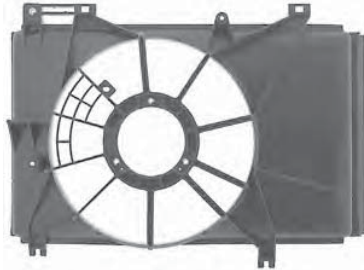
**EM8310**
Mazda 2, 9/07>

Radiator Fan Motor

ZJ38-15-150

**EF1293**
Mazda 2, 9/07>

Radiator Fan Blade

ZJ40-15-140A

**EF1283**
Mazda 2 series I & II, 12/02-8/07

Radiator Fan

ZJ01-15-025C

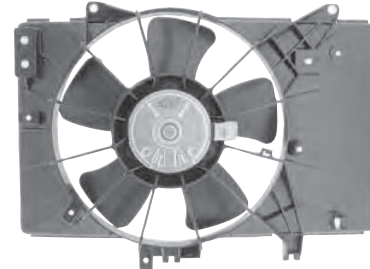
**EF5385**
Mazda 3, 2.0, 2.3Lt, 04>

Radiator Fan

Includes Module
Z602-15-0225B**EF5388**
Mazda 3, 2.0, 2.3Lt, 04>

Radiator Fan Shroud

Z60R-15-0225B

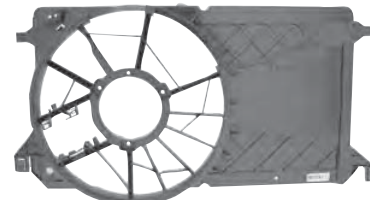
**EF1148**
Mazda 323 Astina BJ
1.6, 1.8, 2Lt, 9/98>
Mazda 323 Protégé BJ
1.6, 1.8, 2Lt, 98>

Radiator Fan

Auto Transmission

**EF5379**
Mazda 323 Astina BJ
1.6, 1.8Lt, 9/98>
Mazda 323 Protégé BJ
1.6, 1.8Lt, 98>

Condenser Fan

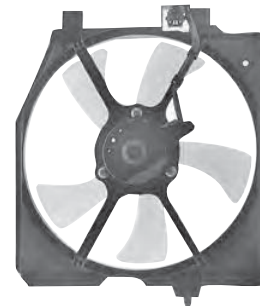

EF5381
Mazda 323 BJ, 9/98>

Radiator Fan

Manual Transmission
ZL04-15-025C



EF5373
Mazda 323 BJ, 1.8Lt, 9/98>

Condenser Fan Shroud

ZL04-15-210B



EF5372
Mazda 323 BJ, 1.8Lt, 9/98>

Radiator Fan Blade

ZL04-15-140



EF1149
Mazda 323 BA, 7/94-9/98
Mazda 323 Protégé BA
1.8Lt, 7/94-9/98

Condenser Fan



EF1151
Mazda 323 BA, 7/94-9/98
Mazda 323 Protégé BA
1.8Lt, 7/94-9/98

Radiator Fan



EF3371
Mazda 323 Astina BA, 7/94-9/98

Condenser Fan

BPD7-15-035

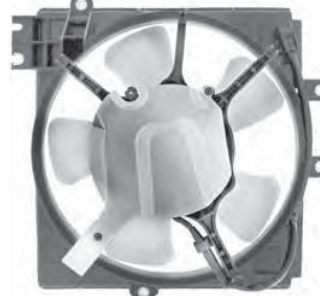

EF1089
Mazda 323, 1.6Lt, 90-95

Radiator Fan

Carburettor engines
Does not suit Astina.



EF1135
Mazda 323, 1.6Lt, 90-95

Condenser Fan



EM6010
Mazda 323 Astina, 1.8Lt Hatch, 92>

Radiator Fan Motor

2 Speed
RFD6-15-150



EF2125
Mazda 6, 12/07>

Dual Assembly

Auto Transmission
Includes Overflow
Bottle

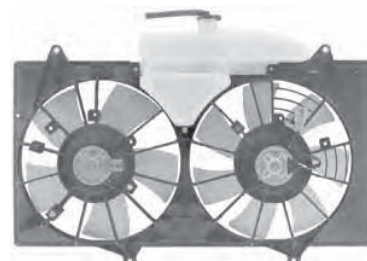

EF2126
Mazda 6, 12/07>

Radiator Fan Shroud

Auto Transmission

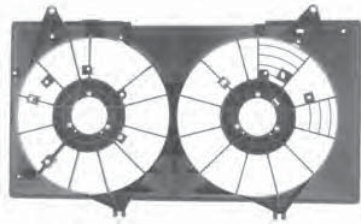

EM6090
Mazda 6, 12/07>

Radiator Fan Motor

Auto Transmission



EM6100
Mazda 6, 12/07>

Radiator Fan Motor

Auto Transmission



EF2127
Mazda 6, 12/07>

Radiator Fan Blade

Auto Transmission
L33D-15-140



EF2129
Mazda 6, 12/07>

Radiator Fan Blade

Auto Transmission
LF4J-15-140



EF2169
Mazda 6, 8/02>

Dual Assembly

Includes Overflow
Bottle
LF20-15-025

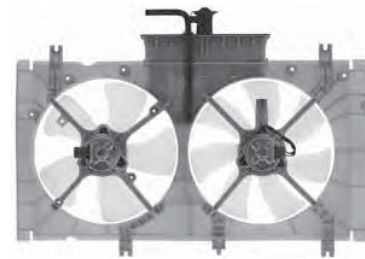

EF1281
Mazda 6, 2.3Lt, 02>

Dual Assembly



EF2120
Mazda 6, 9/04-5/05

Dual Assembly

Includes Overflow
Bottle
Manual Transmission
LF19-15-025

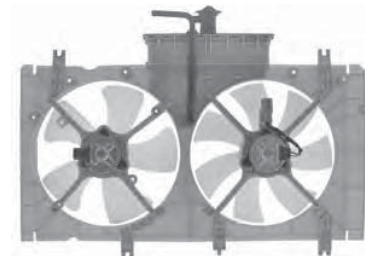

EF2122
Mazda 6, 9/04-5/05

Radiator Fan Shroud

Includes Overflow Bottle
Manual Transmission
LF17-15-210

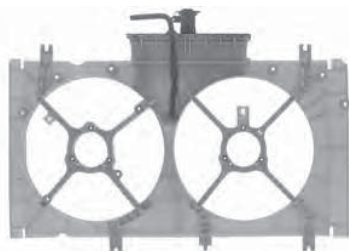

EM5070
Mazda 6, 9/04-5/05

Radiator Fan Motor

Manual Transmission



EM5560
Mazda 6, 9/04-5/05

Radiator Fan Motor

Manual Transmission



EF2121
Mazda 6, 9/04-5/05

Radiator Fan Blade

Manual Transmission



EF2123
Mazda 6, 9/04-5/05

Radiator Fan Blade

Manual Transmission



EF5035
Mazda 626 GF, 6/97>

Condenser Fan

Aftermarket A/C system

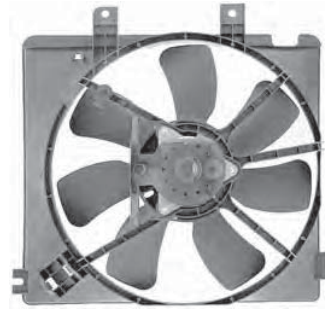

EFFA14
Mazda 626 V6

Condenser Fan

Cooltemp systems



EF1097
Mazda 626, 83-86

Radiator Fan



EF1299
Mazda CX-9, 12/07>

Radiator Fan Shroud

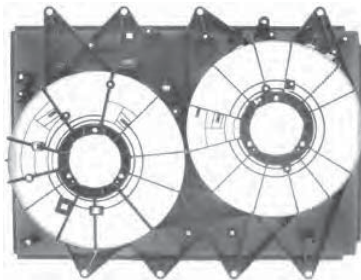

EM5100
Mazda CX-9, 12/07>

Radiator Fan Motor

CY04-15-150A



EM5110
Mazda CX-9, 12/07>

Radiator Fan Motor

CY03-15-150A



EF7040
Mazda CX-9, 12/07>

Radiator Fan Blade

L33L-15-140



EF7520
Mazda CX-9, 12/07>

Radiator Fan Blade

CY03-15-140A



EF1296
Mazda CX-7, 11/06>

Dual Assembly

Includes Module

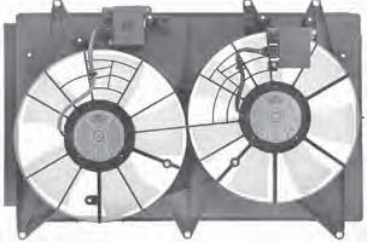

EF1295
Mazda CX-7, 11/06>

Radiator Fan Shroud

L33L-15-210A

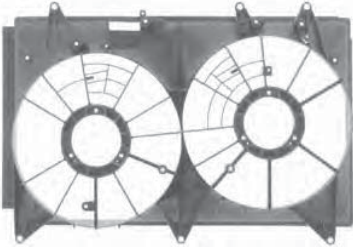

EM5141
Mazda CX-7, 11/06>

Radiator Fan Motor

L37H-15-150A



EM5340
Mazda CX-7, 11/06>

Radiator Fan Motor

L3BT-15-150



EF1294
Mazda CX-7, 11/06>

Radiator Fan Blade



EF1297
Mazda CX-7, 11/06>

Radiator Fan Blade



EF5382
Mazda MPV, 3.0Lt, 00-03

Dual Assembly

AJ55-15-025C

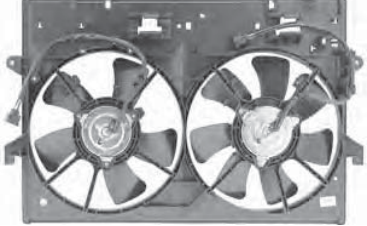

EF5386
Mazda MPV, 96-98

Radiator Fan

LB83-61-710B

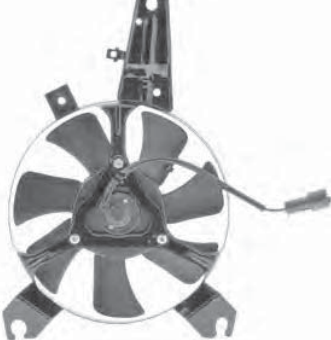

EF0460
Mazda MX5, NB30, 10/00-8/05

Condenser Fan

MAZEF0460



EF5384
Mazda Premacy 1.8, 2.0Lt, 00-03

Radiator Fan



EF5383
Mazda Premacy 1.8, 2.0Lt, 00-03

Condenser Fan



EF5374
Mazda Tribute, 2.0Lt, 4 cyl, 01>

Dual Assembly

YF091502J

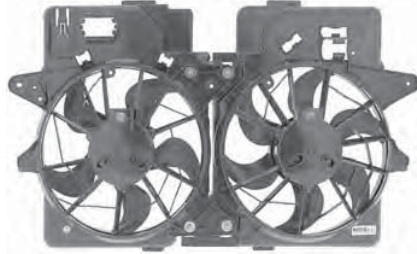

EF5375
Mazda Tribute, 3.0Lt V6, 01>

Dual Assembly

MZAJ06-15-025

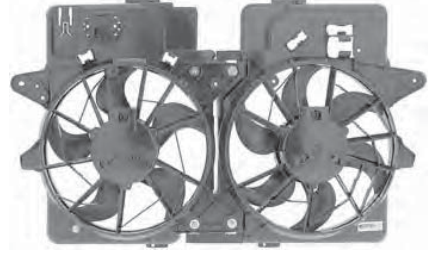

Mercedes Benz

EF1355
Mercedes A Class, A200, 04-09
Mercedes B Class, B180, B200, 05-09

Radiator Fan

Includes Module
1698203642



EF1336
Mercedes A Class, W168, 1.6Lt
7/97-8/04

Radiator Fan

1685000193



EF1330
Mercedes C Class, W203, 00-03

Radiator Fan

Includes Module

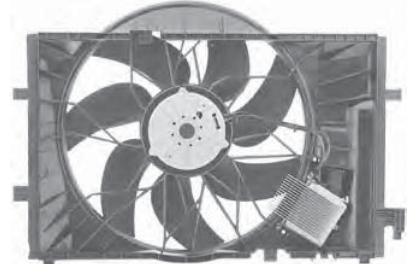

EF1331
Mercedes C Class, W202, 93-00
Mercedes C Class, W124, 94-97

Radiator Fan



EF1354
Mercedes C Class, C180, C200
C230, 93-01

Radiator Fan Motor & Blade

0005401588



EF1337
 Mercedes CLK Class, CLK320, 98-01
 Mercedes SLK320, 98-01

Radiator Fan

0005401688



EF1332
 Mercedes E Class, W124, W210, E430, 96-02
 Mercedes E Class, W124, W210, E320, 97-99
 Mercedes E Class W124, W120, E55, AMG, 00-02

Dual Assembly

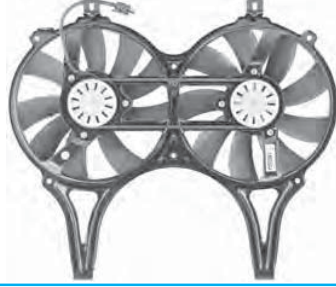

EF1352
 Mercedes E Class, E220, 220E, 230E, 230TE, 300TE, 84-98

Radiator Fan

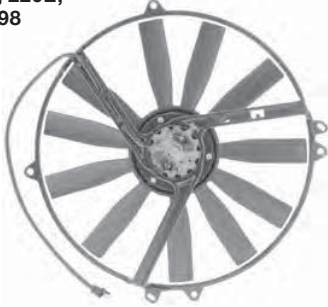

EF1354
 Mercedes E Class, E200, E230, E240 E280, E320, E430, E55, 93-01

Radiator Fan Motor & Blade

0005401588



EF1353
 Mercedes E Class, 300T, 6/93-9/96

Radiator Fan

0005007993

 Picture unavailable at time of printing refer www.cooldrive.com.au

EF1341
 Mercedes W638, MB100, 98-03

Radiator Fan

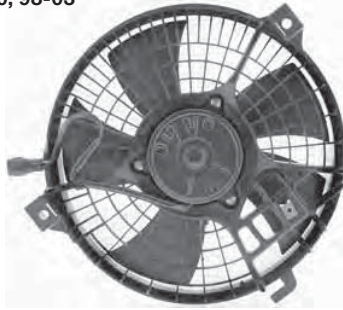

EF1334
 Mercedes ML Class, W163 ML320 ML430, 00-04

Dual Assembly



EF1345
 Mercedes S Class, W220, 6 & 8 cyl, 99-02

Radiator Fan



EF1344
 Mercedes S Class, W140, 92-99

Condenser Fan



EF6540
 Mercedes S Class, W124, W126, 85-91
 Mercedes S Class C126, 81-91

Condenser Fan

0005005093
 0005009293



EF1342
Mercedes Sprinter
Mercedes Vito

Radiator Fan



EF1351
Mercedes Sprinter, 4/01>

Radiator Fan Blade

1032000423



EF1349
Mercedes Vito, 04>

Radiator Fan

A0005050955

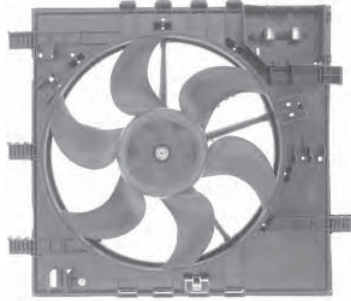

EF1341
Mercedes Vito, W638, 98-03

Radiator Fan

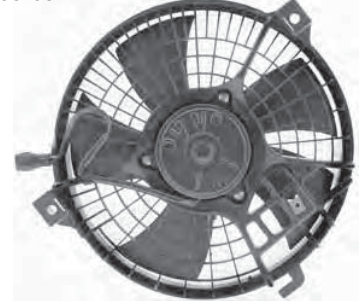

EF1353
Mercedes W201 190, 9/86-8/93

Radiator Fan

0005007993



Picture unavailable at time of printing
refer www.cooldrive.com.au

EF1162
Mercedes W170, W202, C230, SLK200
SLK230K, 96-04

Radiator Fan

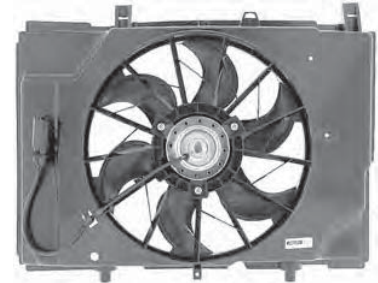

EF1342
Mercedes W124, W126
260E, 300E, 86-89

Radiator Fan



EF1343
Mercedes W126 300E, 350E, 86-89

Radiator Fan



EF1353
Mercedes W124, 200E, 230E, 200D,
250D, 300E, 12/85>

Radiator Fan

0005007993



Picture unavailable at time of printing
refer www.cooldrive.com.au

EF1338
Mercedes W120, E320, 00-02

Radiator Fan

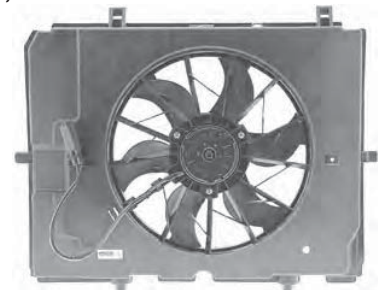

Mini/Mitsubishi

EF6509

Mini Cooper, R56 1.6Lt, 3/07>

Radiator Fan



Picture unavailable at time of printing
refer www.cooldrive.com.au

EF6510

Mini Cooper, 1.6Lt, 01-04

Radiator Fan

Includes Module
17101475577



EF1291

Mitsubishi 380, 10/05>

Radiator Fan

Includes Module



EF1170

Mitsubishi L400 WA Starwagon, 6/94>

Dual Assembly



EF1292

Mitsubishi Lancer CG-CH, 6/00-9/07

Dual Assembly

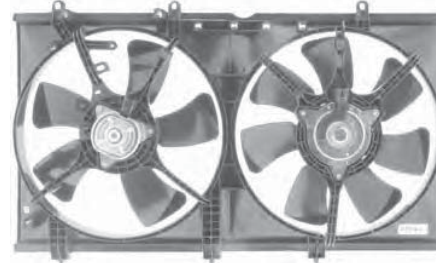

EF1171

Mitsubishi Lancer CE, 5/96-02
Mitsubishi Mirage CE, 5/96-02

Condenser Fan



EF1175

Mitsubishi Lancer CE, 5/96-02
Mitsubishi Mirage CE, 5/96-02

Radiator Fan

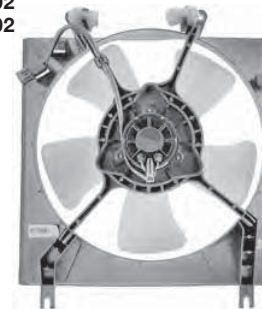

EF1174

Mitsubishi Lancer CC, 6/92-4/96

Radiator Fan



EF5149

Mitsubishi Lancer CC, 6/92-4/96

Condenser Fan



EM3870

Mitsubishi Magna TJ, TL, 8/00>

Radiator Fan Motor

MR552033



EM6321

Mitsubishi Magna TJ, 8/00>

Radiator Fan Motor

MR160893



EM6311

Mitsubishi Magna TJ, 8/00-6/03

Radiator Fan Motor

MR160894



EF1119

Mitsubishi Magna TE, TF, TH, TJ, 2/96>

Condenser Fan



EF1288

Mitsubishi Magna TS, 3/94-3/97

Radiator Fan Blade

MB890937

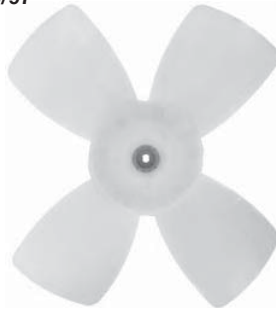

EM7150

Mitsubishi Magna TR, TS, 4 cyl, 91-3/97
Mitsubishi Magna TS, V6, 3/94-3/97

Condenser Fan Motor



EM9000

Mitsubishi Magna TN, TP, 7/87-7/91

Condenser Fan Motor



EM4580

Mitsubishi Magna TM, TN, 7/85-7/91

Radiator Fan Motor

AW313615



EF2178

Mitsubishi Nimbus UG, 99>

Radiator Fan

Includes Module
MR373725



EF3703

Mitsubishi Pajero NM, NP
3.5Lt V6, Petrol
2.8, 3.2Lt Diesel, 5/00>

Condenser Fan

MR360801

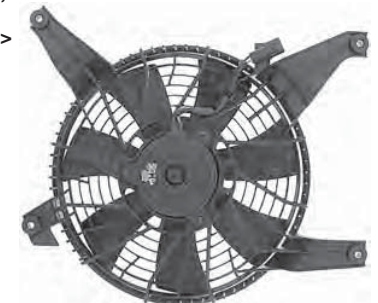

EF2182
 Mitsubishi Pajero, NJ, NK, NL
 3.0, 3.5Lt V6, Petrol
 2.8Lt Diesel, 11/93-6/00

Condenser Fan

MB657380



EM7121
 Mitsubishi Pajero NJ, NK, NL, 11/93>

Condenser Fan Motor

MB878162



EF2162
 Mitsubishi Triton MK, 3.0Lt V6, 01-03

Condenser Fan

Picture unavailable at time of printing
 refer www.cooldrive.com.au



EF1119
 Mitsubishi Verada KE, KF, KH, KJ, 2/96>

Condenser Fan



Nissan

EF1153
 Nissan Maxima A33, 00-01
 Nissan Infiniti 30, 00-01

Dual Assembly



EF1152
 Nissan Maxima A32, 11/94-12/99

Dual Assembly

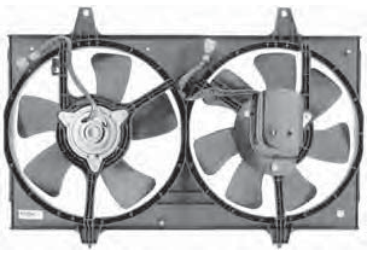

EF1314
 Nissan Micra, 93>

Radiator Fan

Manual Transmission

Picture unavailable at time of printing
 refer www.cooldrive.com.au



EF1303
 Nissan Micra, 93>

Condenser Fan



EF1302
 Nissan Murano, Z50, 3.5Lt V6, 7/05>

Dual Assembly

21481-CA000

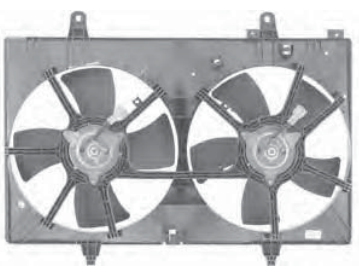

EF1306
Nissan Patrol

Radiator Fan Blade

21060-36J01
21060-03J00



EF5151
Nissan Pulsar N16, 7/00>

Dual Assembly

Suits 4 dr Japan
manufactured
Does not suit 5 dr
UK manufactured

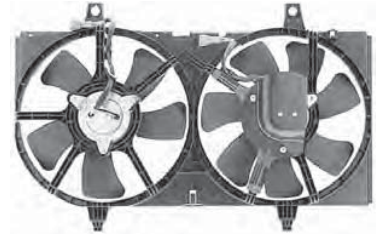

EF1127
Nissan Pulsar N14, N15, 1.6, 2.0Lt, >9/00

Condenser Fan

Auto Transmission
B70022M150



EF5005
Nissan Pulsar N14, 1.6, 2.0Lt, 5/00>

Radiator Fan

Manual Transmission
21481-J9000



EF1115
Nissan Pulsar N12, 4/86-6/87

Condenser Fan



EM0001
Nissan Terrano, 2.4Lt Petrol
2.7Lt Diesel, 98-99

Condenser Fan Motor

Cooltemp systems



EF1306
Nissan Terrano

Radiator Fan Blade

21060-36J01
21060-03J00



EF1307
Nissan Tiida C11, 10/06>

Radiator Fan



Picture unavailable at time of printing
refer www.cooldrive.com.au

EF1301
Nissan X-Trail, 9/01>

Dual Assembly

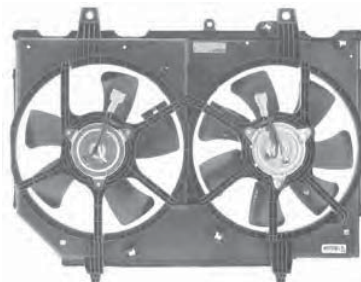

Peugeot/Porsche

EF1209
Peugeot 206, 98>

Radiator Fan



EF1166
Peugeot 306, 4/97-12/02

Dual Assembly



EF1167
Peugeot 306, 95-3/97

Dual Assembly



EF1212
Peugeot 307, 4/01>

Radiator Fan

9634009380



EF1211
Peugeot 406, 97-02

Dual Assembly

Includes Module

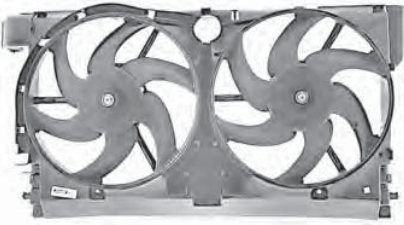

EF1428
Porsche 911, 3.4, 3.6Lt, 97-04
Porsche Boxster, 96-04

Radiator Fan Motor & Blade

Includes Resistor
99662413500



EF1426
Porsche Cayenne, 02-07

Radiator Fan Motor & Blade

Includes Module
95562413601



EF1425
Porsche Cayenne, 02-07

Radiator Fan Motor & Blade

Includes Module
95562413400



EF1219
Porsche Cayenne, 8/03-8/10

Radiator Fan Motor & Blade

95562413500



**Proton/Saab/Seat/
Ssangyong**



EF5149

Proton Persona, 1.5, 1.6Lt, 96>
Proton Wira, 1.5, 1.6Lt, 96>

Condenser Fan



EF1452

Saab 9-5, 6/97-1/09

Radiator Fan Motor & Blade

4576443



EF1454

Saab 9-5, 6/97-1/09

Radiator Fan Motor & Blade

4576351



EF1208

Seat Cordoba, 93-02
Seat Ibiza, 98-99

Radiator Fan Motor & Blade

191959455AF



EF1313

Seat Cordoba, 93-02
Seat Ibiza, 91-99
Seat Toledo, 91-99

Radiator Fan Motor & Blade

6K0959455



EF1218

Seat Cordoba, 2/93-02
Seat Ibiza II, 3/93-99

Radiator Fan Blade

165959455L / N



EF1420

Seat Cordoba, 93-02
Seat Ibiza, 93-97
Seat Toledo, 91-99

Radiator Fan Motor & Blade

357959455L



EF1434

Seat Cordoba, 93-02
Seat Ibiza, 93-02

Radiator Fan Motor & Blade

1H0959455D / E



EF1217

Seat Cordoba, 93-99
Seat Ibiza, 93-99

Radiator Fan Motor & Blade

165959455AA / T



EF1342

Ssangyong Musso

Radiator Fan



Subaru

EF1325
Subaru Forester, 03-05

Dual Assembly

Non Turbo

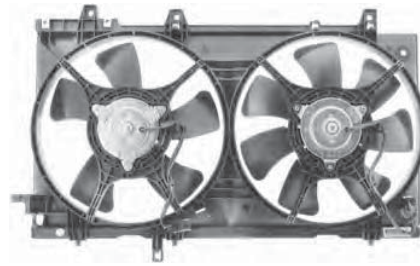
**EF1326**
Subaru Forester, 03-05

Dual Assembly

Turbo

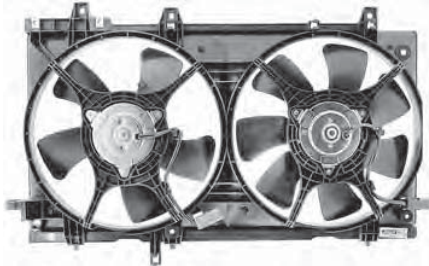
**EF1323**
Subaru Forester, 99-02

Condenser Fan

**EF1324**
Subaru Forester, 2.0Lt, 99-02

Radiator Fan

**EF1327**
Subaru Impreza, 2.0Lt, 02-03

Radiator Fan

**EF1328**
Subaru Impreza, 2.0Lt, 02-03

Condenser Fan

**EF1322**
Subaru Impreza, 02>

Radiator Fan

45122FE000

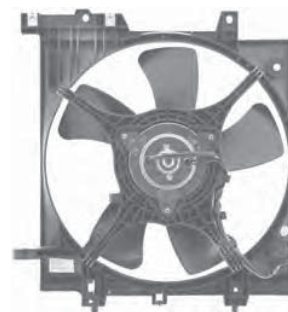
**EF1319**
Subaru Impreza, 98>

Radiator Fan

2 pin connector

**EF1329**
Subaru Impreza, 98>

Condenser Fan

3 pin connector



EF1156

Subaru Impreza, 1.8Lt, >97

Radiator Fan

2 speed



EF1320

Subaru Legacy, 98-03
Subaru Liberty, 98-03

Condenser Fan

73313AE000



EF1321

Subaru Legacy, 98-03
Subaru Liberty, 98-03

Radiator Fan

45122AE000



EF1315

Subaru Liberty, 4 cyl, 02-04

Condenser Fan

73310AE004
73310AE00A



EF1316

Subaru Liberty, 4 cyl, 00-02

Radiator Fan



EF1317

Subaru Liberty, 2.2Lt, 94-98

Condenser Fan



EF1318

Subaru Liberty, 2.2Lt, 94-98

Radiator Fan

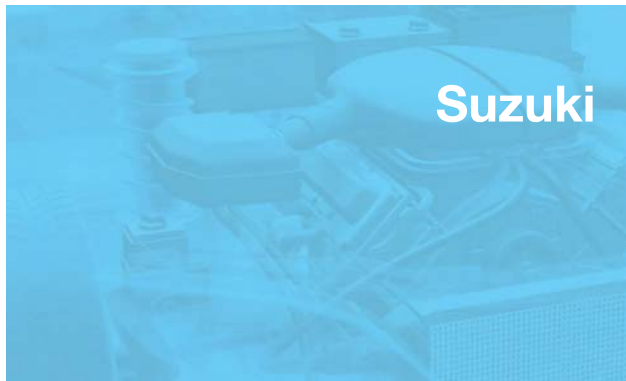

EF3353

Suzuki Baleno, 1.6Lt, 4/95-11/01

Radiator Fan

Denso systems



Picture unavailable at time of printing
refer www.cooldrive.com.au

EF1157

Suzuki Baleno, 95-98
Suzuki Jimny, 98>

Condenser Fan

95560-81A00



EF2320
Suzuki Grand Vitara, 06>

Dual Assembly

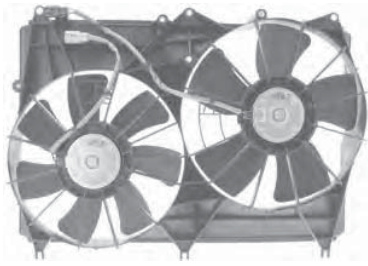

EF2321
Suzuki Grand Vitara, 06>

Radiator Fan Shroud

17760-65J00

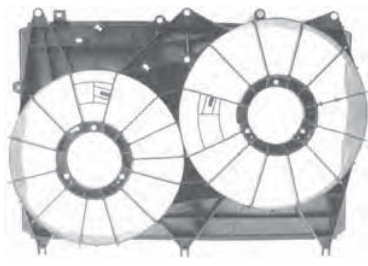

EM9591
Suzuki Grand Vitara, 06>

Radiator Fan Motor

17120-66J00



EM9602
Suzuki Grand Vitara, 06>

Radiator Fan Motor

Auto Transmission
17120-66J10



EF2322
Suzuki Grand Vitara, 06>

Radiator Fan Blade

17111-66J00



EF2149
Suzuki Grand Vitara, 06>

Radiator Fan Blade

Auto Transmission
17111-66J10



EF2325
Suzuki Ignis

Radiator Fan

17100-80G00



EF3352
Suzuki Liana, 2.4Lt, 11/01-3/04

Condenser Fan



Picture unavailable at time of printing
refer www.cooldrive.com.au

EF2326
Suzuki Swift EZ, Series I & II, 2/05>

Radiator Fan

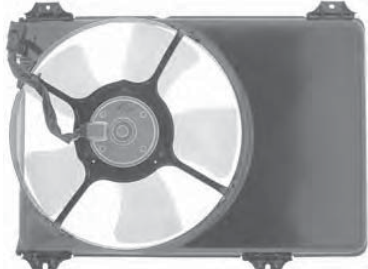

EF2327
Suzuki Swift EZ, Series I & II, 2/05>

Radiator Fan Shroud

17760-63J00

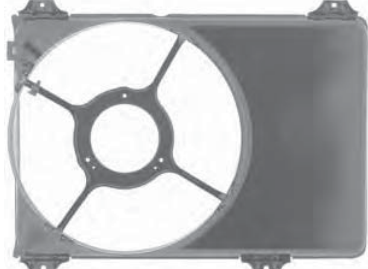

EM8310

Suzuki Swift EZ, Series I & II, 2/05>

Radiator Fan Motor

17120-80J00



EF2183

Suzuki Vitara TD01, 5 Door P/S, 95>

Condenser Fan

5 Door only
Power Steering
95320-57B50

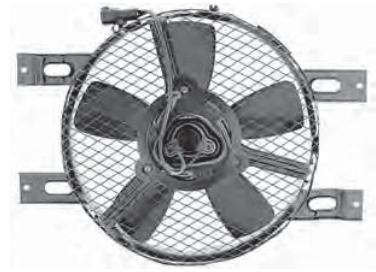

EM1810

Toyota 4 Runner LN130R, RN130R
VZN130R, 4/89-6/96

Condenser Fan Motor

88550-89101-A



EF2141

Toyota Aurion GSV40R, 10/06>

Radiator Fan Shroud

16711-0P090

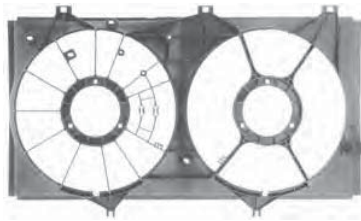

EM8240

Toyota Aurion GSV40R, 10/06>

Radiator Fan Motor

16363-0P090



EF2145

Toyota Aurion GSV40R, 10/06>

Radiator Fan Blade

16361-0P080



EF2184

Toyota Avalon MCX10, 7/00-3/06

Condenser Fan

16370-20010-D



EF1780

Toyota Avalon MCX10, 7/00-3/06

Condenser Fan Shroud

16711-0A020-B

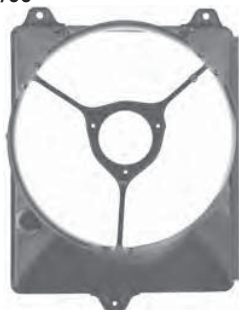

EM0094

Toyota Avalon MCX10, 7/00-3/06

Condenser Fan Motor

166200-0094



EF2610

Toyota Avalon MCX10, 7/00-3/06

Condenser Fan Blade

16361-0A020-A



EF2304

Toyota Avensis Verso ACM20R, ACM21R
5/01>

Radiator Fan Shroud

16711-28230

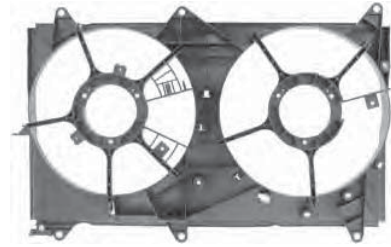

EM2312

Toyota Avensis Verso ACM20R, ACM21R
12/01-11/10

Radiator Fan Motor

Driver side
16363-23030



EM7725

Toyota Avensis Verso ACM20R, ACM21R
12/01-11/10

Radiator Fan Motor

Passenger side
16363-28100



EF2312

Toyota Avensis Verso ACM20R, ACM21R
12/01-11/10

Radiator Fan Blade

Driver side
16361-28050



EF2303

Toyota Avensis Verso ACM20R, ACM21R
12/01-11/10

Radiator Fan Blade

Passenger side
16361-23050



EF2355

Toyota Camry AHV40R, Hybrid, 2/10>

Radiator Fan Shroud

16711-28310

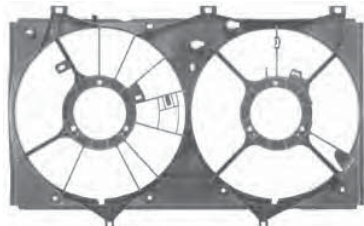

EM7680

Toyota Camry AHV40R, Hybrid, 2/10>

Radiator Fan Motor

16363-28270



EF2354

Toyota Camry AHV40R, Hybrid, 2/10>

Radiator Fan Blade

5 Blade
16361-28280



Picture unavailable at time of printing
refer www.cooldrive.com.au

EF2357

Toyota Camry AHV40R, Hybrid, 2/10>

Radiator Fan Blade

7 Blade
16361-28270



Picture unavailable at time of printing
refer www.cooldrive.com.au

EF2134
Toyota Camry ACV40R, 7/06-1/12

Dual Assembly

16360-0H151

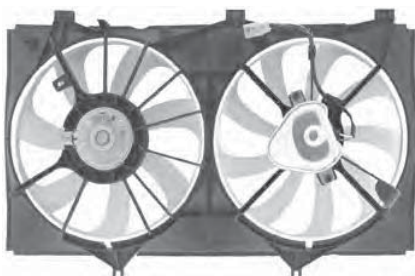

EF2138
Toyota Camry ACV40R, 7/06-1/12

Radiator Fan Shroud

16711-0H140

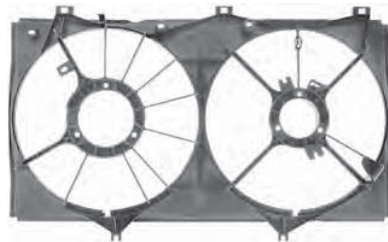

EM5960
Toyota Camry ACV40R, 7/06-1/12

Radiator Fan Motor

16363-0H090



EM9720
Toyota Camry ACV40R, 7/06-1/12

Radiator Fan Motor

16363-0H110M



EF2135
Toyota Camry ACV40R, 7/06-1/12

Radiator Fan Blade

9 blade
16361-0H270



EF2137
Toyota Camry ACV40R, 7/06-1/12

Radiator Fan Blade

7 blade
16361-0H240



EF2199
Toyota Camry ACV36, 4 cyl, 9/02-6/06
Toyota Camry MCV36, V6, 9/02-6/06

Radiator Fan Shroud

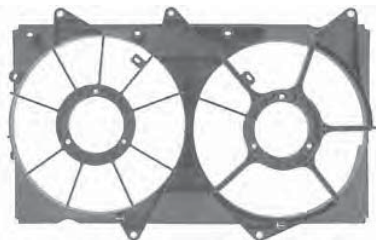

EM2131
Toyota Camry ACV36, 4 cyl, 9/02-6/06
Toyota Camry MCV36, V6, 9/02-6/06

Radiator Fan Motor

Passenger side
168000-4100



EM2133
Toyota Camry ACV36, 4 cyl, 9/02-6/06
Toyota Camry MCV36, V6, 9/02-6/06

Radiator Fan Motor

Driver side
168000-4120



EF2133
Toyota Camry ACV36, 4 cyl, 9/02-6/06
Toyota Camry MCV36, V6, 9/02-6/06

Radiator Fan Blade

Driver side



EF2131

Toyota Camry ACV36, 4 cyl, 9/02-6/06
Toyota Camry MCV36, V6, 9/02-6/06

Radiator Fan Blade

Passenger side

**EF2186**

Toyota Camry MCV20R, V6, 8/97-8/02

Condenser Fan

16360-0A120

**EF2187**

Toyota Camry MCV20R, V6, 8/97-8/02

Condenser Fan

Auto Transmission
88590-YC020

**EF2160**

Toyota Camry MCV20R, V6, 8/97-8/02

Condenser Fan Shroud

88454-33020

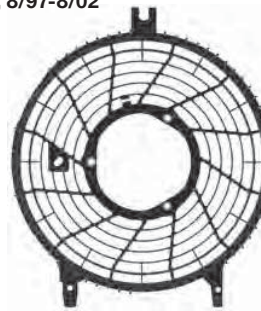
**EM2521**

Toyota Camry MCV20R, V6, 8/97-8/02

Condenser Fan Motor

88550-12160

**EM0150**

Toyota Camry MCV20R, V6, 8/97-8/02

Radiator Fan Motor

16363-0A040

**EF2191**

Toyota Camry SXV20R, 4 cyl, 8/97-8/02

Radiator Fan

16360-03110

**EM5311**

Toyota Camry SXV20R, 4 cyl, 8/97-8/02
Toyota Camry MCV20R, V6, 8/97-9/02

Radiator Fan Motor

16363-74370

**EF2188**

Toyota Camry SXV20R, 4 cyl, 8/97-8/02

Condenser Fan

16370-74080

**EM5250**

Toyota Camry SXV20R, 4 cyl, 8/97-8/02
Toyota Camry MCV20R, V6, 8/97-9/02

Condenser Fan Motor



EF2179

Toyota Camry SXV20R, 4 cyl, 8/97-8/02

Condenser Fan Shroud

16711-03100

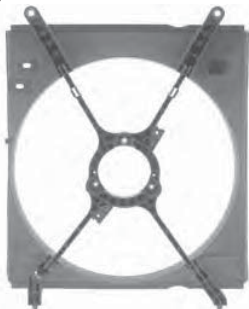

EF2185

Toyota Camry SDV10, 4 cyl, 11/92-7/97

Condenser Fan



EF0480

Toyota Camry SDV10, 4 cyl, 11/92-7/97

Condenser Fan Shroud

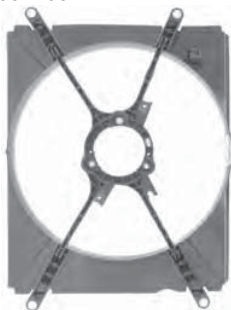

EM0070

Toyota Camry SDV10, 4 cyl, 11/92-7/97

Condenser Fan Motor



EF1980

Toyota Camry SDV10, 4 cyl, 11/92-7/97

Condenser Fan Blade

88453-33010



EM0065

Toyota Camry SDV10, 4 cyl, 11/92-7/97

Radiator Fan Motor



EF2159

Toyota Camry SV22, 9/89-2/93

Radiator Fan Shroud

Manual Transmission
16711-03030



EF1104

Toyota Camry SV21, 5/87-2/93

Radiator Fan



EM7180

Toyota Camry SV21, SV22, 5/87-2/93

Radiator Fan Motor

16363-7400F



EF2198

Toyota Celica ZZT231R, 1.8Lt, 11/99-3/06

Dual Assembly

16360-22030-B

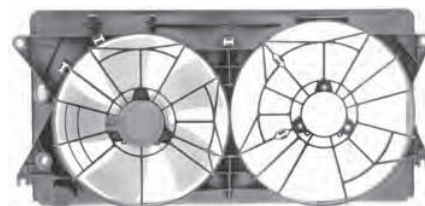

EF3770

Toyota Celica ZZT231R, 1.8Lt, 11/99-3/06

Radiator Fan Blade

16361-22060

**EM7723**

Toyota Celica ST204, 205, 2/94>

Radiator Fan Motor

16363-704020-H

**EM0372**

Toyota Coaster

Condenser Fan Motor

24V

**EM0860**

Toyota Coaster

Condenser Fan Motor

24V 160W

**EF1890**

Toyota Corolla ZRE152R, 5/07>

Radiator Fan

Includes Module

**EF1891**

Toyota Corolla ZRE152R, 5/07>

Radiator Fan Shroud

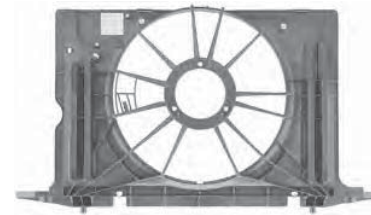
**EF1893**

Toyota Corolla ZRE152R, 5/07>

Radiator cover

16712-22040

**EM1890**

Toyota Corolla ZRE152R, 5/07>

Radiator Fan Motor

16363-22120-A

**EF1892**

Toyota Corolla ZRE152R, 5/07>

Radiator Fan Blade

16361-22100-A

**EF2872**

Toyota Corolla ZZE122R, 12/01>

Radiator Fan

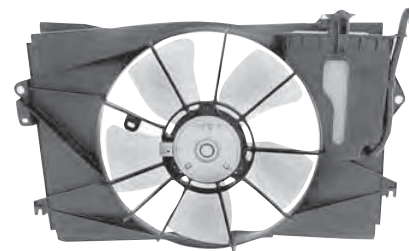
Includes OverFlow
Bottle
16360-21160

EF2181

Toyota Corolla ZZE122R, 12/01>

Radiator Fan Shroud

Includes OverFlow
Bottle
16711-21080-A

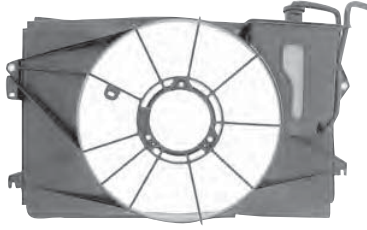

EM3540

Toyota Corolla ZZE122R, 12/01>

Radiator Fan Motor

16363-0D040-A



EF2180

Toyota Corolla ZZE122R, 12/01>

Radiator Fan Blade

16361-21060

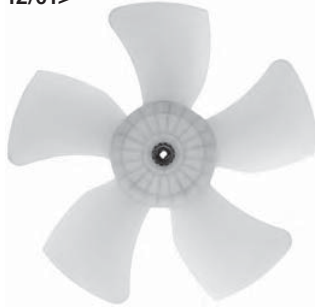

EF2194

Toyota Corolla AE112, 8/98-9/01

Radiator Fan



EF1520

Toyota Corolla AE112, 8/98-9/01

Radiator Fan Shroud

16711-15281-B



EM7723

Toyota Corolla AE112, 8/98>

Radiator Fan Motor

16363-704020-H



EF0420

Toyota Corolla AE112, 8/98-9/01

Radiator Fan Blade

16361-63020-A

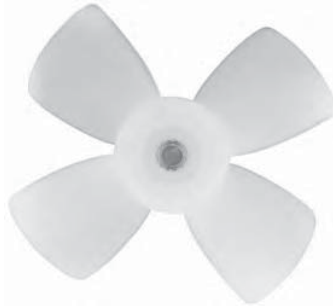

EF5102

Toyota Corolla AE111, AE112, 8/98-9/01

Condenser Fan

88590-12250-A

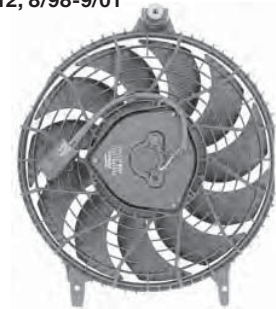

EF1187

Toyota Corolla AE101, AE102, 2/94-8/99

Condenser Fan

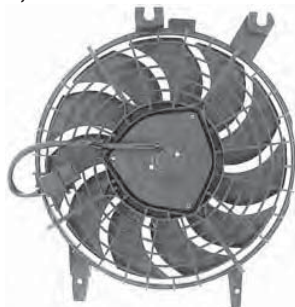

EF1103

Toyota Corolla AE90, AE92, AE93, 2/89-7/94

Radiator Fan

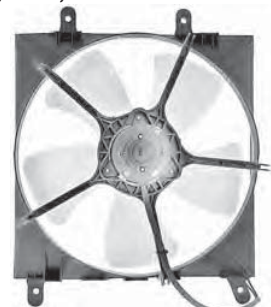

EF1116Toyota Corolla AE90, AE92, AE93, AE94
AE95, AE96, 2/89-8/95

Condenser Fan

**EF1137**

Toyota Corolla, 89-92

Condenser Fan

**EF2177**Toyota Echo NCP10, NCP12
1.3, 1.5Lt, 10/99>

Radiator Fan

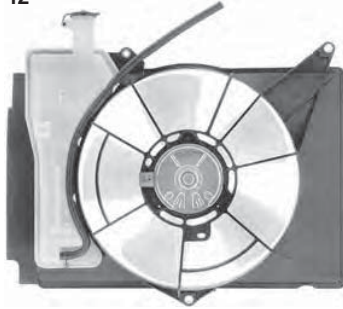
Includes OverFlow Bottle
16360-21030-J**EM2303**Toyota Echo NCP10R, NCP12R
NCP13R, 3/99>

Radiator Fan Motor

16363-28170

**EM2312**Toyota Echo NCP10R, NCP12R
NCP13R, 3/99>

Radiator Fan Motor

16363-23030

**EF2197**Toyota Hiace LH103, LH113, RZH103,
RZH113 8/93-7/98

Condenser Fan

88590-26100

**EM2196**Toyota Hiace LH103, LH113, RZH103,
RZH113, RZH125, 8/93-7/98

Condenser Fan Motor

**EF2140**Toyota Hiace, KDH200R, KDH201R
KDH220R, KDH221R, KDH222R,
KDH223R, 3/05>

Auxiliary Radiator Fan

16730-30010

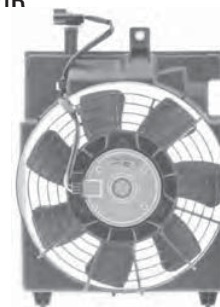
**EF2142**Toyota Hiace, KDH200R, KDH201R
KDH220R, KDH221R, KDH222R,
KDH223R, 3/05>

Auxiliary Radiator Fan Shroud

16711-30050-A

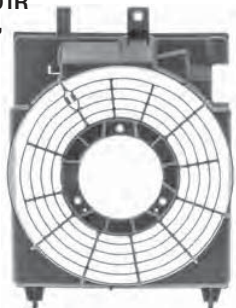
**EM7780**Toyota Hiace, KDH200R, KDH201R
KDH220R, KDH221R, KDH222R,
KDH223R, 3/05>

Auxiliary Radiator Fan Motor

16363-30010



EF2143

Toyota Hiace, KDH200R, KDH201R
KDH220R, KDH221R, KDH222R,
KDH223R, 3/05>

Auxiliary Radiator Blade

88453-37030



Picture unavailable at time of printing
refer www.cooldrive.com.au

EF2175

Toyota Hiace, KDH200R, KDH201R, KDH220R
KDH221R, KDH222R, KDH223R,
TRH201R, TRH221R, TRH2213R, 3/05>

Radiator Fan Shroud

16712-75121



EM4780

Toyota Hiace, KDH200R, KDH201R, KDH220R
KDH221R, KDH222R, KDH223R,
TRH201R, TRH221R, TRH2213R, 3/05>

Radiator Fan Motor

16363-20390



EM4810

Toyota Hiace, KDH200R, KDH201R, KDH220R
KDH221R, KDH222R, KDH223R,
TRH201R, TRH221R, TRH2213R, 3/05>

Radiator Fan Motor

16363-75030



EF2340

Toyota Kluger GSU40R, GSU45R, 8/07>

Dual Assembly

Includes Overflow Bottle

16360-31200



Picture unavailable at time of printing
refer www.cooldrive.com.au

EF2341

Toyota Kluger GSU40R, GSU45R, 8/07>

Radiator Fan Shroud

Includes Overflow
Bottle
16711-31370

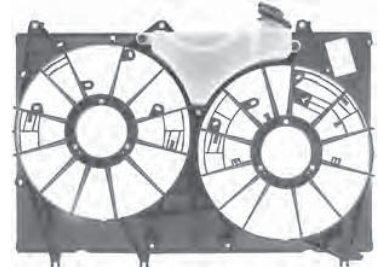

EM9220

Toyota Kluger GSU40R, GSU45R, 8/07>

Radiator Fan Motor

16363-46170



EM9221

Toyota Kluger GSU40R, GSU45R, 8/07>

Radiator Fan Motor

16363-31210



EF2342

Toyota Kluger GSU40R, GSU45R, 8/07>

Radiator Fan Blade

16361-31270



EF2343

Toyota Kluger GSU40R, GSU45R, 8/07>

Radiator Fan Blade

16361-31280



EF2196
Toyota Kluger MCU28, 11/03-7/07

Dual Assembly

Includes Module
16360-20100-B

EF2302
Toyota Kluger MCU28, 11/03-7/07

Radiator Fan Shroud

16711-20120-A

EM7724
Toyota Kluger MCU28, 11/03-7/07

Radiator Fan Motor

16363-20310

EF2300
Toyota Kluger MCU28, 11/03-7/07

Radiator Fan Blade

16361-20210

EF2301
Toyota Kluger MCU28, 11/03-7/07

Radiator Fan Blade

16361-20200-A

EF5490
Toyota Landcruiser 200 Series, VDJ200R
UZJ200R, 11/07>

Condenser Fan

88590-60080

Picture unavailable at time of printing
refer www.cooldrive.com.au

EF5492
Toyota Landcruiser 200 Series, VDJ200R
UZJ200R, 11/07>

Condenser Fan Shroud

88454-60050

Picture unavailable at time of printing
refer www.cooldrive.com.au

EM3360
Toyota Landcruiser 200 Series, VDJ200R
UZJ200R, 11/07>

Radiator Fan Motor

88550-60110

EF5499
Toyota Landcruiser 200 Series, VDJ200R
UZJ200R, 11/07>

Condenser Fan Blade

7 blade
88453-60020

Picture unavailable at time of printing
refer www.cooldrive.com.au

EF2190
Toyota Landcruiser 100 Series, FZJ105
UZJ100, V8, 1/98-10/03

Condenser Fan

Auto Transmission
88590-60030-B

EM2130

Toyota Landcruiser 100 Series, FZJ105
UZJ100, V8, 1/98-10/03

Condenser Fan Motor

16363-64080-D



EF1114

Toyota Lexcen VR, VS, 6/93-5/97

Condenser Fan



EM5330

Toyota MR2 ZZW30, 8/00>

Condenser Fan Motor

16363-22060



EM7723

Toyota MR2 SW20, 12/91-8/00

Radiator Fan Motor

16363-704020-H



EM2420

Toyota Paseo, 96>

Condenser Fan Motor



EF2480

Toyota Paseo EL54, 8/95-7/99

Condenser Fan

88590-16070-D



EF1290

Toyota Paseo EL54, 8/95-7/99

Condenser Fan Shroud

88454-16140-A



EM2440

Toyota Paseo EL54, 8/95-7/99

Condenser Fan Motor

16363-74180



EF2130

Toyota Paseo EL54, 8/95-7/99

Condenser Fan Blade

88453-20040



EF2351

Toyota Prius ZVW30, 4/09>

Radiator Fan Shroud

16711-37060

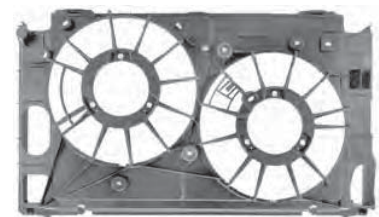

EM8980

Toyota Prius ZVW30, 4/09>

Radiator Fan Motor

16363-37010

Picture unavailable at time of printing
refer www.cooldrive.com.au**EM8990**

Toyota Prius ZVW30, 4/09>

Radiator Fan Motor

16363-37020

Picture unavailable at time of printing
refer www.cooldrive.com.au**EF2352**

Toyota Prius ZVW30, 4/09>

Radiator Fan Blade

7 Blade
16361-37010Picture unavailable at time of printing
refer www.cooldrive.com.au**EF2353**

Toyota Prius ZVW30, 4/09>

Radiator Fan Blade

9 Blade
16361-28360Picture unavailable at time of printing
refer www.cooldrive.com.au**EF2484**

Toyota Prius NHW20R, 11/03-6/09

Dual Assembly

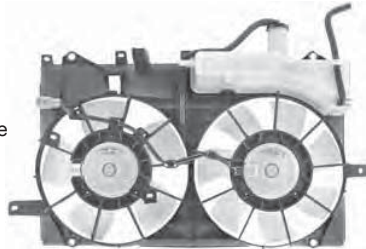
Includes Overflow Bottle
16360-21131**EF2485**

Toyota Prius NHW20R, 11/03-6/09

Radiator Fan Shroud

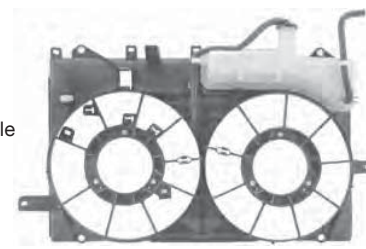
Includes Overflow Bottle
16711-21100**EM7250**

Toyota Prius NHW20R, 11/03-6/09

Radiator Fan Motor

16363-21030

**EM7420**

Toyota Prius NHW20R, 11/03-6/09

Radiator Fan Motor

16363-21040

**EF2571**

Toyota Prius NHW20R, 11/03-6/09

Radiator Fan Blade

7 Blade
16361-28080Picture unavailable at time of printing
refer www.cooldrive.com.au**EF2572**

Toyota Prius NHW20R, 11/03-6/09

Radiator Fan Blade

5 Blade
16361-21040

EM2303

Toyota Rav4 ACA38R, 3/10>

Radiator Fan Motor

Passenger side
16363-28170



EM2312

Toyota Rav4 ACA38R, 3/10>

Radiator Fan Motor

Driver side
16363-23030
168000-3550



EF2338

Toyota Rav4 GSA33R, 3.5Lt V6, 10/07>

Dual Assembly

Includes Module

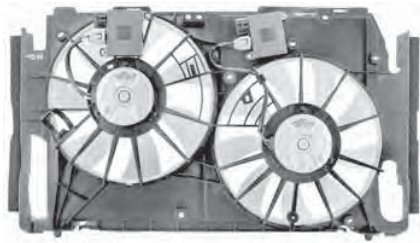

EF2335

Toyota Rav4 GSA33R, 3.5Lt V6, 10/07>

Radiator Fan Shroud

16711-31270

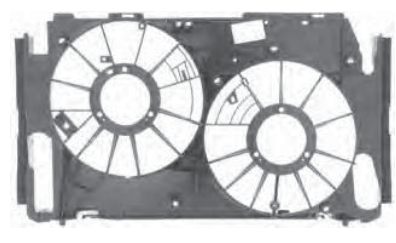

EF2336

Toyota Rav4 GSA33R, 3.5Lt V6, 10/07>

Radiator Cover

16712-31071



EF2338J

Toyota Rav4 GSA33R, 3.5Lt V6, 10/07>

Dual Assembly



Picture unavailable at time of printing
refer www.cooldrive.com.au

EF2305

Toyota Rav4 ACA33R, 11/05>

Dual Assembly

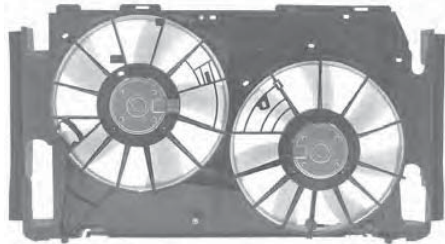

EF2309

Toyota Rav4 ACA33R, 11/05>

Radiator Fan Shroud

16711-28320

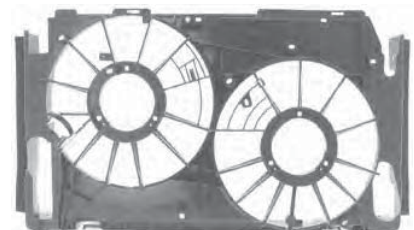

EF2319

Toyota Rav4 ACA33R, 11/05>

Radiator Cover

16712-28050



EM9170

Toyota Rav4 ACA33R, 11/05>

Radiator Fan Motor

16363-28170-A



EF2313
Toyota Rav4 ACA33R, 11/05>

Radiator Fan Blade

16361-28220



EF2314
Toyota Rav4 ACA33R, 11/05>

Radiator Fan Blade

16361-28240



EF2193
Toyota Rav4 ACA20, ACA21, 5/00>

Radiator Fan

16360-28111-A



EF2337
Toyota Rav4 ACA20, ACA21, 5/00>

Radiator Fan Blade

Picture unavailable at time of printing
refer www.cooldrive.com.au



EF2192
Toyota Rav4 ACA20, ACA21, 5/00>

Condenser Fan

16370-28020-C



EF2308
Toyota Rav4 ACA20, ACA21, 5/00>

Condenser Fan Shroud

16711-28180-B



EM7320
Toyota Rav4 ACA20, ACA21, 5/00>

Radiator Fan Motor

16363-28050



EF2334
Toyota Rav4 ACA20, ACA21, 5/00>

Radiator Fan Blade

Picture unavailable at time of printing
refer www.cooldrive.com.au



EF2195
Toyota Rav4 SXA10R, SXA11R, 7/94-9/00

Radiator Fan

16360-74530-B



EF1760
Toyota Rav4 SXA10R, SXA11R, 7/94-9/00

Radiator Fan Shroud

16711-74540-A



EM0620

Toyota Rav4 SXA10R, SXA11R, 7/94-9/00

Radiator Fan Motor

Manual Transmission



EM9660

Toyota Rav4 SXA10R, SXA11R, 7/94-9/00

Radiator Fan Motor

Auto Transmission
16363-28290



EF0730

Toyota Rav4 SXA10R, SXA11R, 7/94-9/00

Radiator Fan Blade

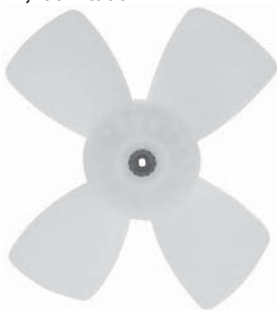

EF2189

Toyota Rav4 SXA10R, SXA11R, 7/94-9/00

Condenser Fan

Manual Transmission
88590-42021-A



EF2307

Toyota Rav4 SXA10R, SXA11R, 7/94-9/00

Condenser Fan Shroud

Manual Transmission
88454-42021-A

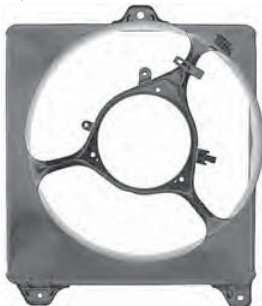

EF2360

Toyota Rav4 SXA10R, SXA11R, 7/94-9/00

Condenser Fan

Auto Transmission
88590-42020-C



EF2306

Toyota Rav4 SXA10R, SXA11R, 7/94-9/00

Condenser Fan Shroud

Auto Transmission
88454-42020-B



EM7200

Toyota Rav4 SXA10R, SXA11R, 7/94-9/00

Condenser Fan Motor

16363-74190-B



EF2590

Toyota Rav4 SXA10R, SXA11R, 7/94-9/00

Condenser Fan Blade

88453-42010



EF2395

Toyota Rukus AZE15R, 5/10>

Radiator Fan Shroud

16711-28400

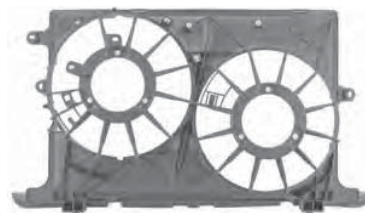

EM8560
Toyota Rukus AZE15R, 5/10>

Radiator Fan Motor

16363-28400

Picture unavailable at time of printing
refer www.cooldrive.com.au

EF2392
Toyota Rukus AZE15R, 5/10>

Radiator Fan Blade

7 Blade
16361-28350

Picture unavailable at time of printing
refer www.cooldrive.com.au

EF2393
Toyota Rukus AZE15R, 5/10>

Radiator Fan Blade

9 Blade
16361-28360

Picture unavailable at time of printing
refer www.cooldrive.com.au

EF2871
Toyota Starlet EP91, 11/96-8/99

Radiator Fan

Manual Transmission
16360-11150-K



EF2870
Toyota Starlet EP91, 11/96-8/99

Condenser Fan

Manual Transmission
88590-10040-B

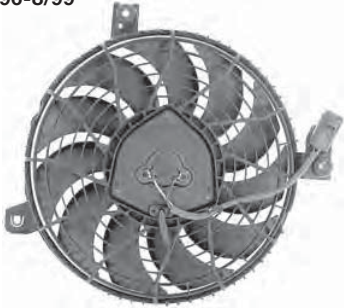

EF1560
Toyota Starlet EP91, 11/96-8/99

Condenser Fan Shroud

Manual Transmission
88454-10100-A

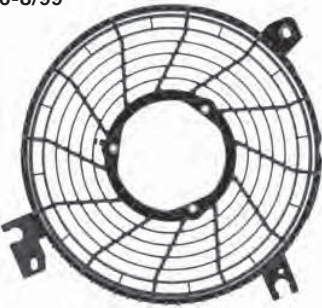

EM2330
Toyota Starlet EP91, 11/96-8/99

Condenser Fan Motor

Manual Transmission
88550-12140



EF2580
Toyota Starlet EP91, 11/96-8/99

Condenser Fan Blade

Manual Transmission
88453-10020



EF2330
Toyota Tarago GSR50R, V6, 2/07>

Dual Assembly

Includes Module
16360-31220

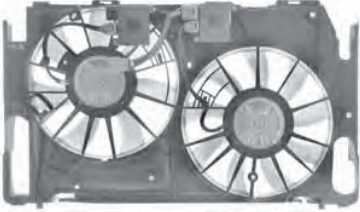

EF2331
Toyota Tarago GSR50R, V6, 2/07>

Radiator Fan Shroud

16711-31300

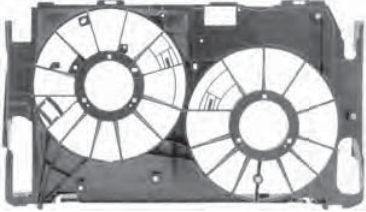

EM2319

Toyota Tarago GSR50R, V6, 2/07>

Radiator Fan Motor

16363-31130



EM2320

Toyota Tarago GSR50R, V6, 2/07>

Radiator Fan Motor

16363-31180



EF2332

Toyota Tarago GSR50R, V6, 2/07>

Radiator Fan Blade

7 Blade
16361-31170



EF2333

Toyota Tarago GSR50R, V6, 2/07>

Radiator Fan Blade

16361-31160



Picture unavailable at time of printing
refer www.cooldrive.com.au

EF2315

Toyota Tarago ACR50R, 3/06>

Dual Assembly

16360-28340

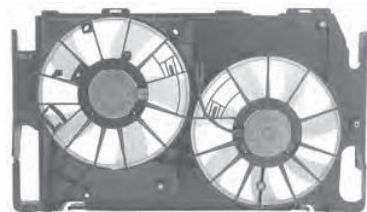

EF2316

Toyota Tarago ACR50R, 3/06>

Radiator Fan Shroud

16711-28340

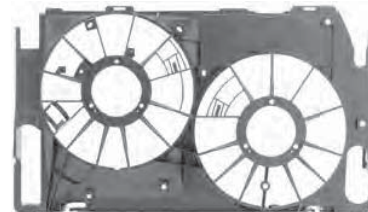

EF2324

Toyota Tarago ACR50R, 3/06>

Radiator Fan Shroud

Tow pack upgrade
16711-28350



Picture unavailable at time of printing
refer www.cooldrive.com.au

EM2303

Toyota Tarago ACR50R, 3/06>

Radiator Fan Motor

Passenger side
16363-28170



EM2312

Toyota Tarago ACR50R, 3/06>

Radiator Fan Motor

Driver side
16363-23030



EM2317

Toyota Tarago ACR50R, 3/06>

Radiator Fan Motor

Tow Pack Upgrade
Passenger Side
16363-28300



EM2318
Toyota Tarago ACR50R, 3/06>

Radiator Fan Motor

Tow Pack Upgrade
Driver side



EF2317
Toyota Tarago ACR50R, 3/06>

Radiator Fan Blade

Passenger Side
16361-28230



EF2318
Toyota Tarago ACR50R, 3/06>

Radiator Fan Blade

Driver Side
16361-28250



EF2231
Toyota Tarago ACR50R, 3/06>

Radiator Cover

16712-31060



EF2311
Toyota Tarago ACR30R, 6/00-2/06

Radiator Fan Shroud

16711-28110

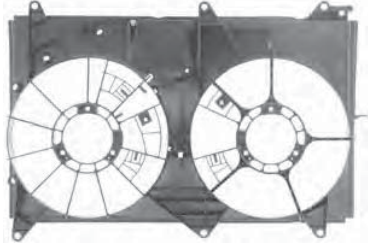

EM2312
Toyota Tarago ACR30R, 6/00-2/06

Radiator Fan Motor

Driver side
16363-23030



EM2303
Toyota Tarago ACR30R, 6/00-2/06

Radiator Fan Motor

Passenger side
16363-28170



EF2303
Toyota Tarago ACR30R, 6/00-2/06

Radiator Fan Blade

16361-23050



EF2312
Toyota Tarago ACR30R, 6/00-2/06

Radiator Fan Blade

Driver side
16361-28050



EM2521
Toyota Townace KR42R, 2/97-2/05

Radiator Fan Motor



EF2545
 Toyota Yaris NCP90R, NCP91R
 NCP93R, 11/05>

Radiator Fan

Includes Overflow Bottle

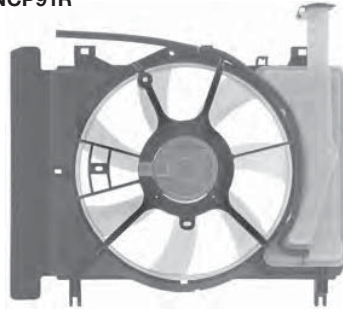

EM9130
 Toyota Yaris NCP90R, NCP91R
 NCP93R, 11/05>

Radiator Fan Motor



Volkswagen

EF1176
 Volkswagen Beetle, 00>

Dual Assembly

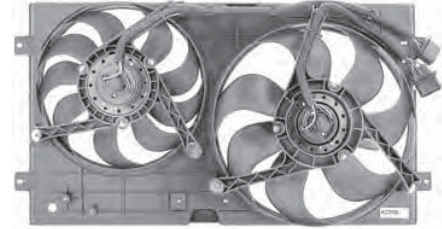

EM1176
 Volkswagen Beetle, 00>

Radiator Fan Motor & Blade

Passenger side, small



EM1177
 Volkswagen Beetle, 00>

Radiator Fan Motor & Blade

Driver side, Large



EF1216
 Volkswagen Beetle, 10/99-6/04
 Volkswagen Bora, 10/98-5/05

Radiator Fan Motor & Blade

345mm diameter
 6X0959455A / F



EF1237
 Volkswagen Bora, 12/99-7/01

Dual Assembly



Picture unavailable at time of printing
 refer www.cooldrive.com.au

EF1238
 Volkswagen Bora, 12/99-7/01

Radiator Fan



Picture unavailable at time of printing
 refer www.cooldrive.com.au

EF1434
 Volkswagen Caddy II, 11/95-5/97

Radiator Fan Motor & Blade

1H0959455D / E



EF1217

Volkswagen Caddy, 8/82-5/97

Radiator Fan Motor & Blade

165959455AA / T

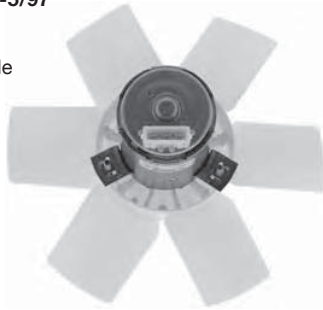
**EF1424**

Volkswagen Caravelle T5, 03-09

Radiator Fan Motor & Blade

7H0959455D

**EF1422**

Volkswagen Caravelle T5, 03-09

Radiator Fan Motor & Blade

7H0959455A

**EF1431**

Volkswagen Caravelle T4, 90-03

Radiator Fan Motor & Blade

701959455K

**EF1423**

Volkswagen Golf IV Cabriolet, 6/98-6/02

Radiator Fan Motor & Blade

1H0959455A

**EF1216**

Volkswagen Golf IV, 8/97-6/05

Radiator Fan Motor & Blade

345mm diameter
6X0959455A / F**EF1423**

Volkswagen Golf III, 91-98

Radiator Fan Motor & Blade

1H0959455A

**EF1434**

Volkswagen Golf II, III & IV, 90-91

Radiator Fan Motor & Blade

1H0959455D / E

**EF1208**

Volkswagen Golf II, 90-92

Radiator Fan Motor & Blade

1H0959455B / D / E

**EF1430**

Volkswagen Golf II, 1.8Lt, 8/87-7/90

Radiator Fan Motor & Blade

191959455T



EF1217
Volkswagen Golf II, 90-92

Radiator Fan Motor & Blade

165959455AA / T

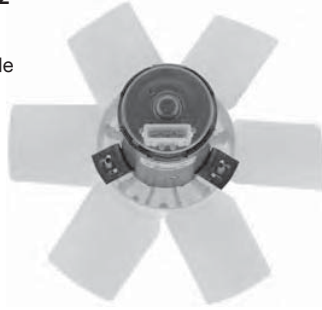

EF1218
Volkswagen Golf I & II, 83-93
Volkswagen Jetta, 1/84-12/91

Radiator Fan Motor & Blade

165959455L / N

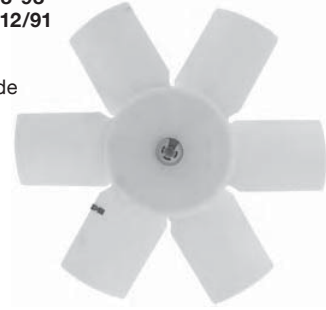

EF1434
Volkswagen Jetta II, 1/84-12/91

Radiator Fan Motor & Blade

1H0959455D / E



EF1430
Volkswagen Jetta, 8/84-7/90

Radiator Fan Motor & Blade

191959455T



EF1424
Volkswagen Multivan T5, 03-09

Radiator Fan Motor & Blade

7H0959455D



EF1422
Volkswagen Multivan T5, 03-09

Radiator Fan Motor & Blade

7H0959455A



EF1219
Volkswagen Multivan, 4/03-11/09

Radiator Fan Motor & Blade

7L0959455B / E



EF1423
Volkswagen Passat, 91-97

Radiator Fan Motor & Blade

1H0959455A



EF1420
Volkswagen Passat, 91-97

Radiator Fan Motor & Blade

357959455L



EF1434
Volkswagen Passat, 91-97

Radiator Fan Motor & Blade

1H0959455D / E



EF1218Volkswagen Passat, 1/86-8/96
Volkswagen Polo, 83-93

Radiator Fan Motor & Blade

165959455L / N

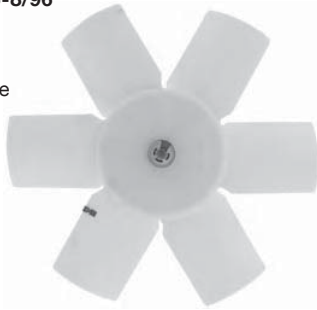
**EF1217**

Volkswagen Passat, 8/85-8/96

Radiator Fan Motor & Blade

165959455AA / T

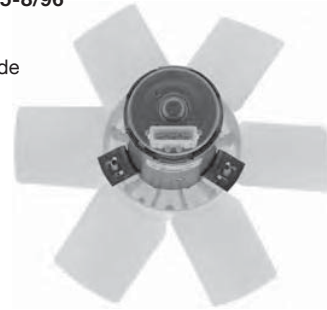
**EF1227**

Volkswagen Polo III, 12/03-5/08

Radiator Fan Motor & Blade

392mm diameter
6Q0959455ADPicture unavailable at time of printing
refer www.cooldrive.com.au**EF1216**

Volkswagen Polo III, 7/95-9/01

Radiator Fan Motor & Blade

345mm diameter
6X0959455A / F**EF1219**

Volkswagen Touareg, 9/03-5/10

Radiator Fan Motor & Blade

7L0959455B / E

**EF1425**

Volkswagen Touareg, 02-09

Radiator Fan Motor & Blade

Includes Module
7L0959455F**EF1426**

Volkswagen Touareg, 02-09

Radiator Fan Motor & Blade

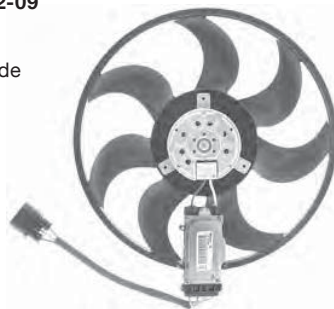
Includes Module
7L0959455G**EF1219**

Volkswagen Transporter T5, 4/03-11/09

Radiator Fan Motor & Blade

7L0959455B / E

**EF1422**

Volkswagen Transporter T5, 03>

Radiator Fan Motor & Blade

7H0959455A

**EF1424**

Volkswagen Transporter T5, 03>

Radiator Fan Motor & Blade

7H0959455D



EF1214

Volkswagen Transporter T4, 98>

Dual Assembly

701959455J

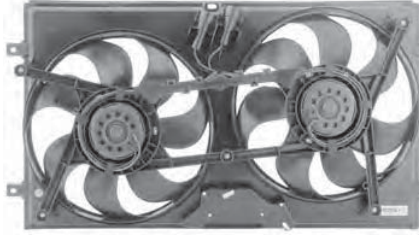

EF1215

Volkswagen Transporter T4, 90-97

Dual Assembly

701959455AM

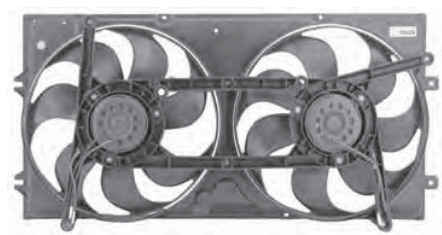

EF1431

Volkswagen Transporter T4, 90>

Radiator Fan Motor & Blade

701959455K



EF1423

Volkswagen Vento, 95-97

Radiator Fan Motor & Blade

1H0959455A



EF1434

Volkswagen Vento, 95-97

Radiator Fan Motor & Blade

1H0959455D / E



Fan Clutches

Contact CoolDrive Sales team for more detail on our extensive range of quality fan clutches



Fan Clutch Features –

- Heavy duty, precision machined shafts
- Heat inhibiting silicone fluid
- Quality Bearings
- Heavy duty drive plates
- Die cast aluminium bodies providing maximum strength and weight advantage

Silicone Oil Lubricant

OG6000

Silicone oil lubricant used for the repair in viscous fan clutches, OG6000 can be used in all vehicle applications including commercial, passenger motor vehicle, earth moving and stationary engines.

- Manufacturers guidelines should always be followed when replacing viscous fan hub oil.



Fan clutch performance should always be considered when vehicles are experiencing any overheating symptoms while driving in traffic, low speed environments, or while towing or carrying heavy loads. It is possible the fan clutch has degenerated gradually over time or its silicone based fluid has lost viscosity or leaked. The result is the fan clutch loses the ability to “drive” the fan blades at the required speed to move sufficient air across the cooling components (condenser, radiator, oil coolers).

Key indicators of wear are leaking fluid streaks or excessive blade movement, indicating worn clutch hub bearings.

Fan clutch hubs should always be considered for replacement in conjunction with water pump failures.

Water Pumps

Contact CoolDrive Sales team for more detail on our extensive range of replacement water pumps from our Engine Cooling Division



TFC114

Ford / Mazda

Courier PC, PD, PE, PG, PH, 2.6Lt 4cyl G6, 10/91-11/06
B2600 Bravo, 2.6Lt 4cyl G6, G6E, 12/90-7/06



TFC102

Holden

Commodore VP, VR, VS, 5.0Lt V8, 11/91-12/00
Commodore VL, VN, VG Ute, 5.0Lt V8, 3/86-8/88
Commodore VB, VC, VH, VK, 4.2, 5.0Lt V8, 11/78-2/86
Commodore VB, VC, VH, VK, 1.9Lt 4cyl, 2.8,
3.3Lt 6cyl, 11/78-2/86
Commodore VB, VC, 2.8Lt 6cyl, 11/78-9/81



TFC105

Mitsubishi

Challenger PA, 3.0Lt V6 6G72, 3/98-3/07
Delica 4WD, 2.5Lt 4cyl 4D65T, 1/89-12/95
Express L300 SF, SG, SH, SJ, 2.5Lt 4cyl 4D56, 1086-6/03
Express L200 MC, MD, 2.3Lt 4cyl 4D55, 10/82-10/86
Pajero NJ, NK, NL, 3.5Lt V6 6G74, 9/95-6/00
Pajero NG, NH, NJ, NK, 3.0Lt V6 6G72, 9/98-7/97
Pajero NG, NH, 2.5Lt 4cyl 4D56T, 9/89-10/93
Pajero NF, 3.0Lt V6 6G72, 5/88-8/89
Pajero NA, NF, 2.3, 2.5Lt 4cyl 4D55T, 4D56T eng. 5/84-8-89
Triton MH, MJ, MK, 3.0Lt V6 6G72, 9/90-10/06
Triton ME, MF, MG, MH, MJ,
2.5Lt 4cyl 4D56, 4D56T,
12/86-10/96



TFC167

Nissan

Patrol GU, 4.2Lt 6cyl Turbo TD42T, 5/98-4/07
Patrol GU, 4.5Lt 6cyl TB45E, 12/97-9/01
Patrol GQ, 4.2Lt 6cyl TB42E, 2/92-12/97



TFC106

Toyota

Landcruiser HDJ80, 4.2Lt 6cyl 1HDT, 1HDFE, 5/90-3/95
Landcruiser HDJ78, HDJ79, 4.2Lt 6cyl 1HDFTE, 11/01-3/07
Landcruiser HZJ78, HZJ79, 4.2Lt 6cyl 1HZ, 10/99-3/07
Landcruiser HZJ70, HZJ73, HZJ75, 4.2Lt 6cyl 1HZ, 1/90-10/99



TFC151

Toyota

Hilux KZN165, 3.0Lt 4cyl 1KZTE, 1/98-3/05
Prado KZJ95, KZJ120, 3.0Lt 4cyl 1KZTE, 3/00-11/06

